

## NATIVA

### Installation manual

Dimensions:

120x180 cm

150x180 cm

150x200 cm

200x200 cm

200x250 cm

Handedness:

Left



# Leave space for better assembly

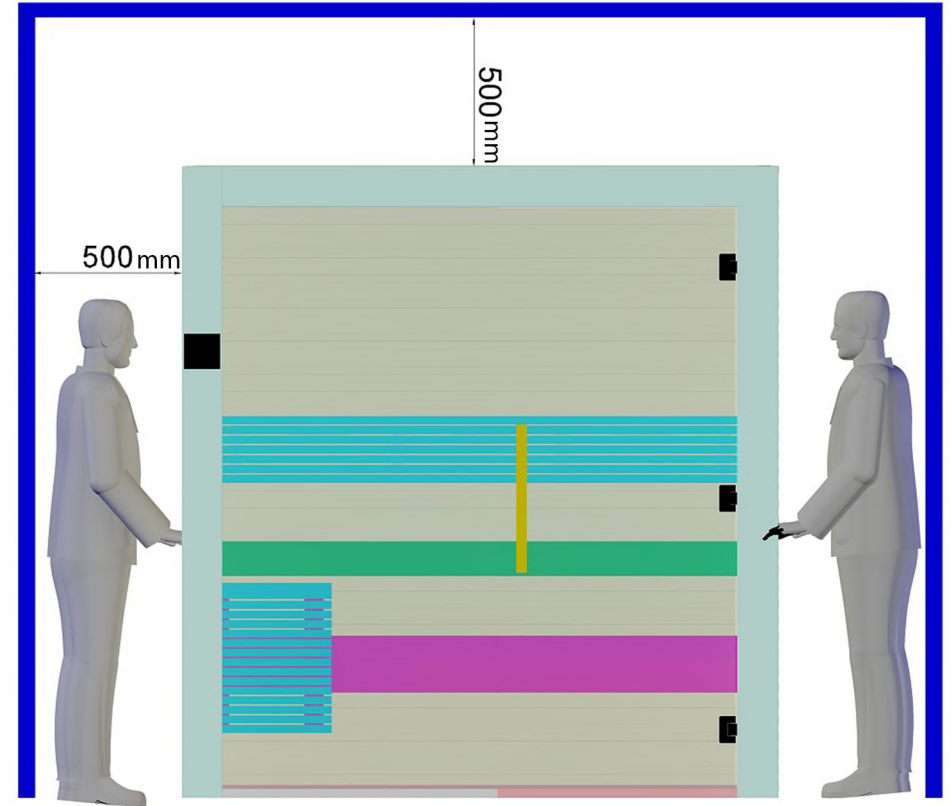
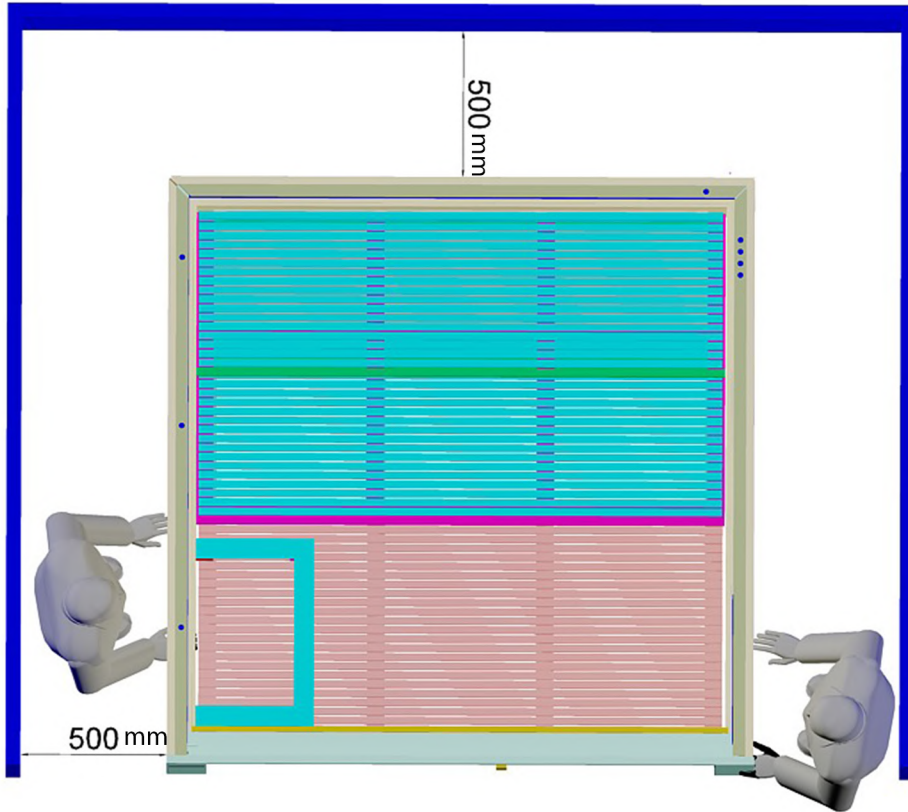

# Tools

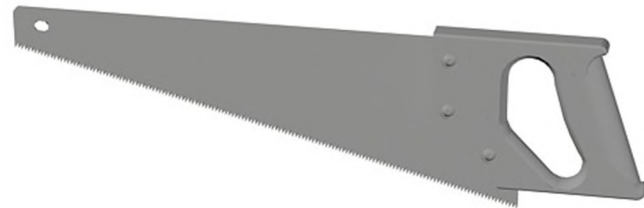
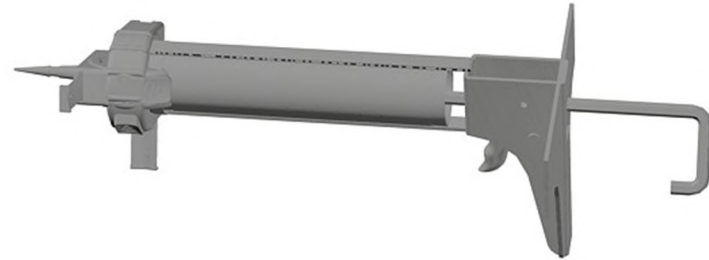

# 1. Base frame

	x (mm)	y (mm)
120x180 cm	2088	1746
150x180 cm	2267	1746
150x200 cm	2424	1946
200x200 cm	2752	1946
200x250 cm	3126	2446

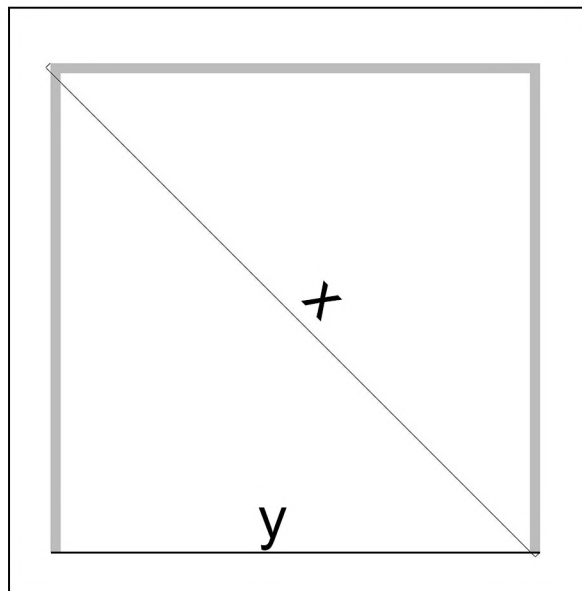
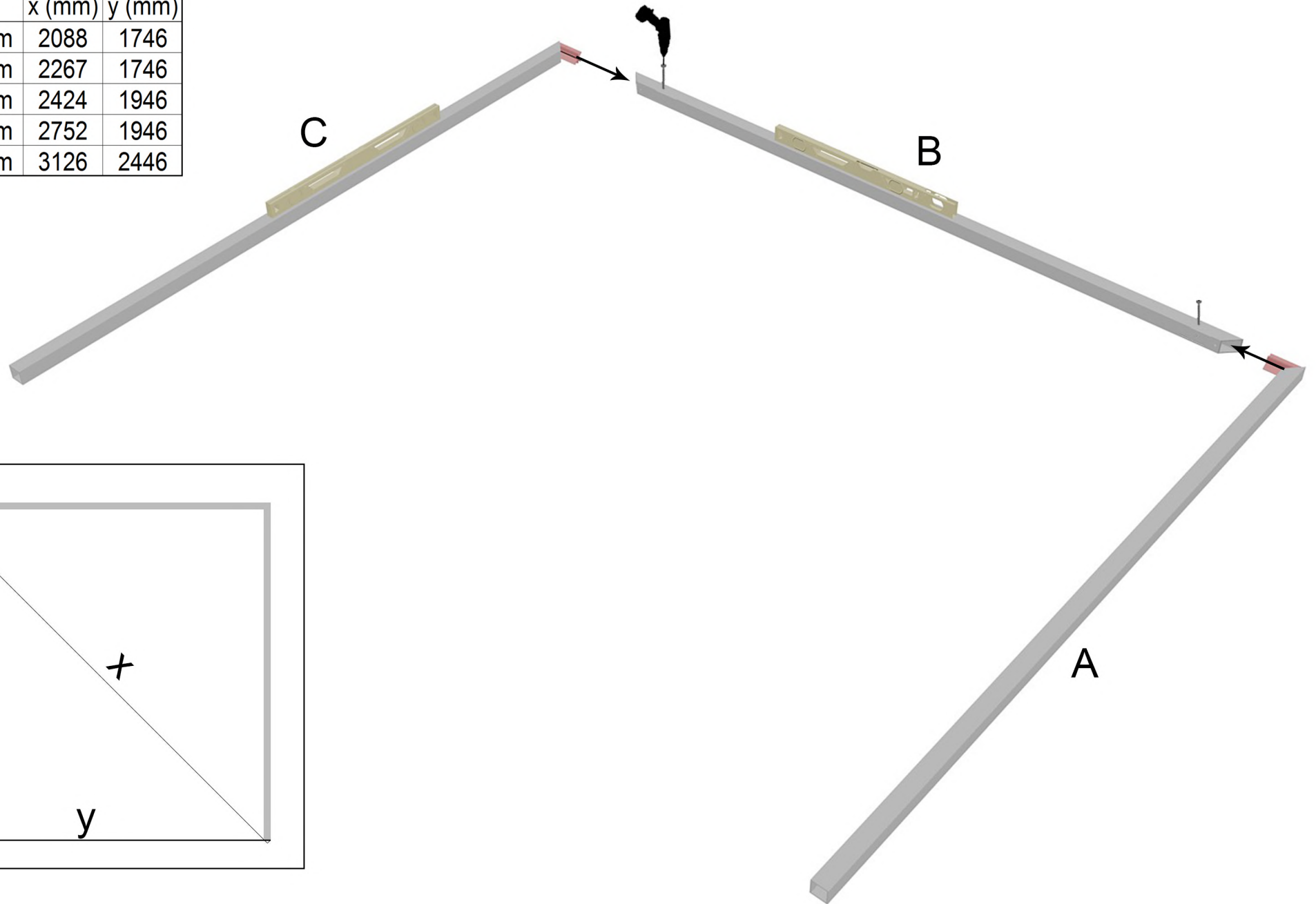

## 2. Walls

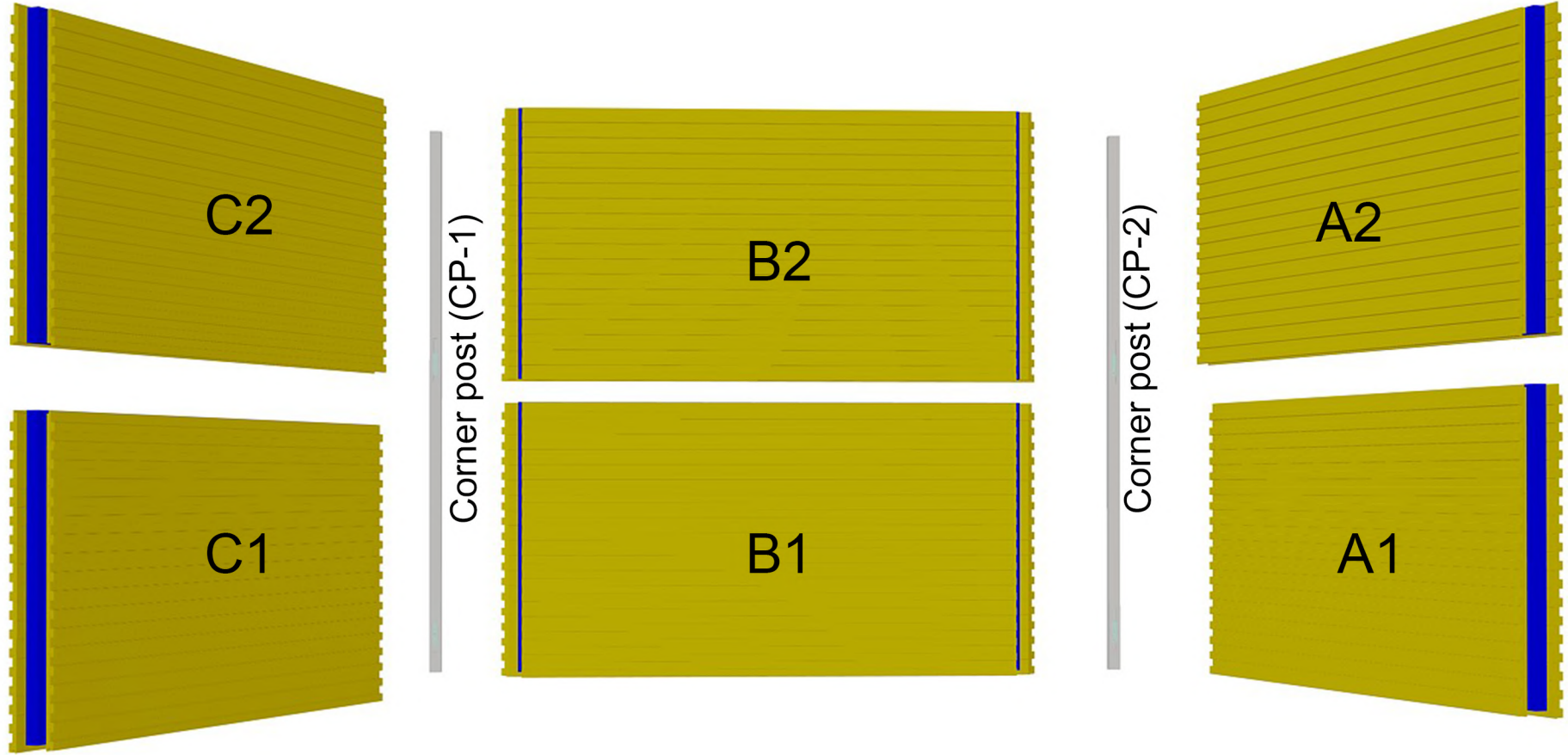

### 3. Multiclip closing system

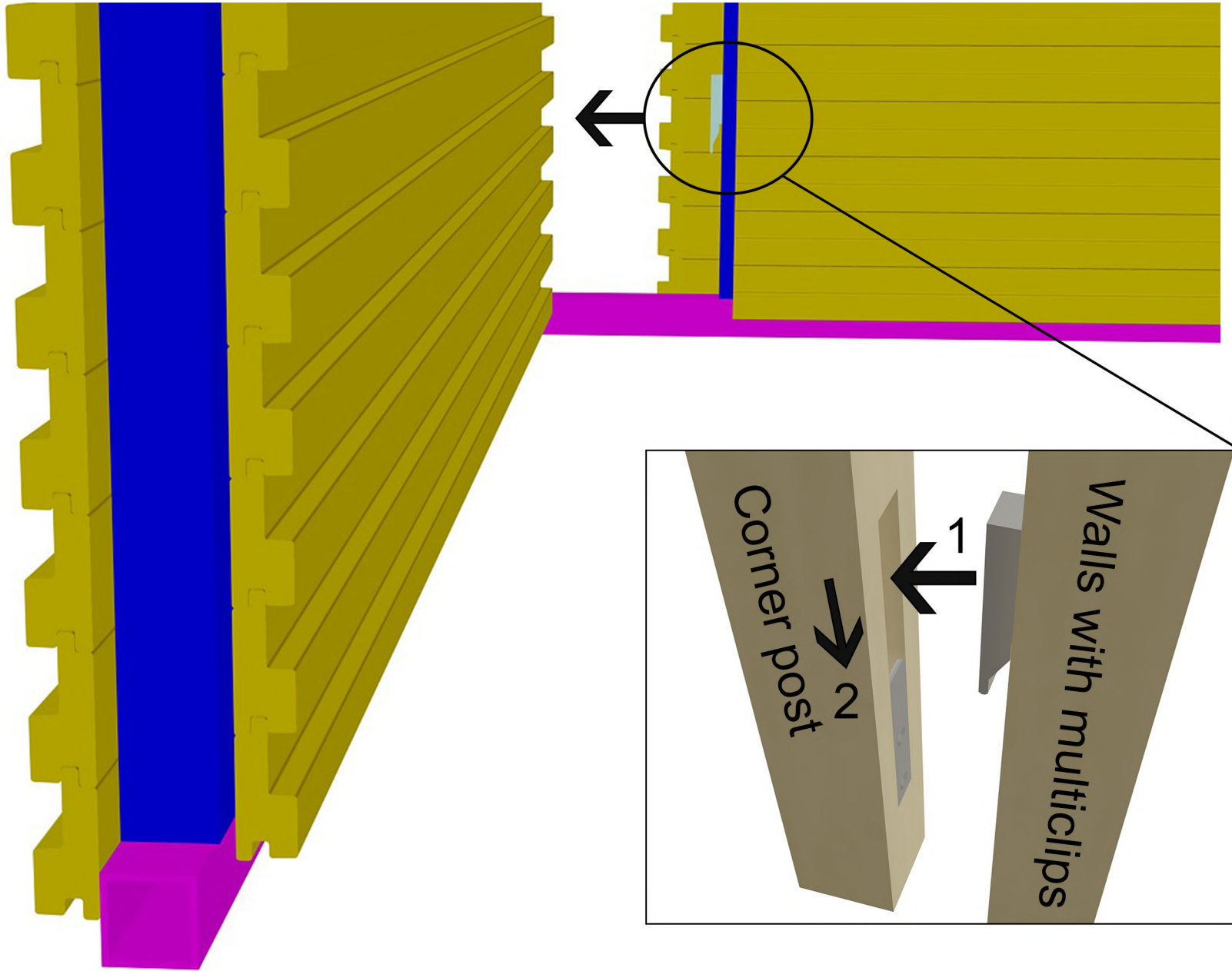

# 4. Fixing walls A1 & B1

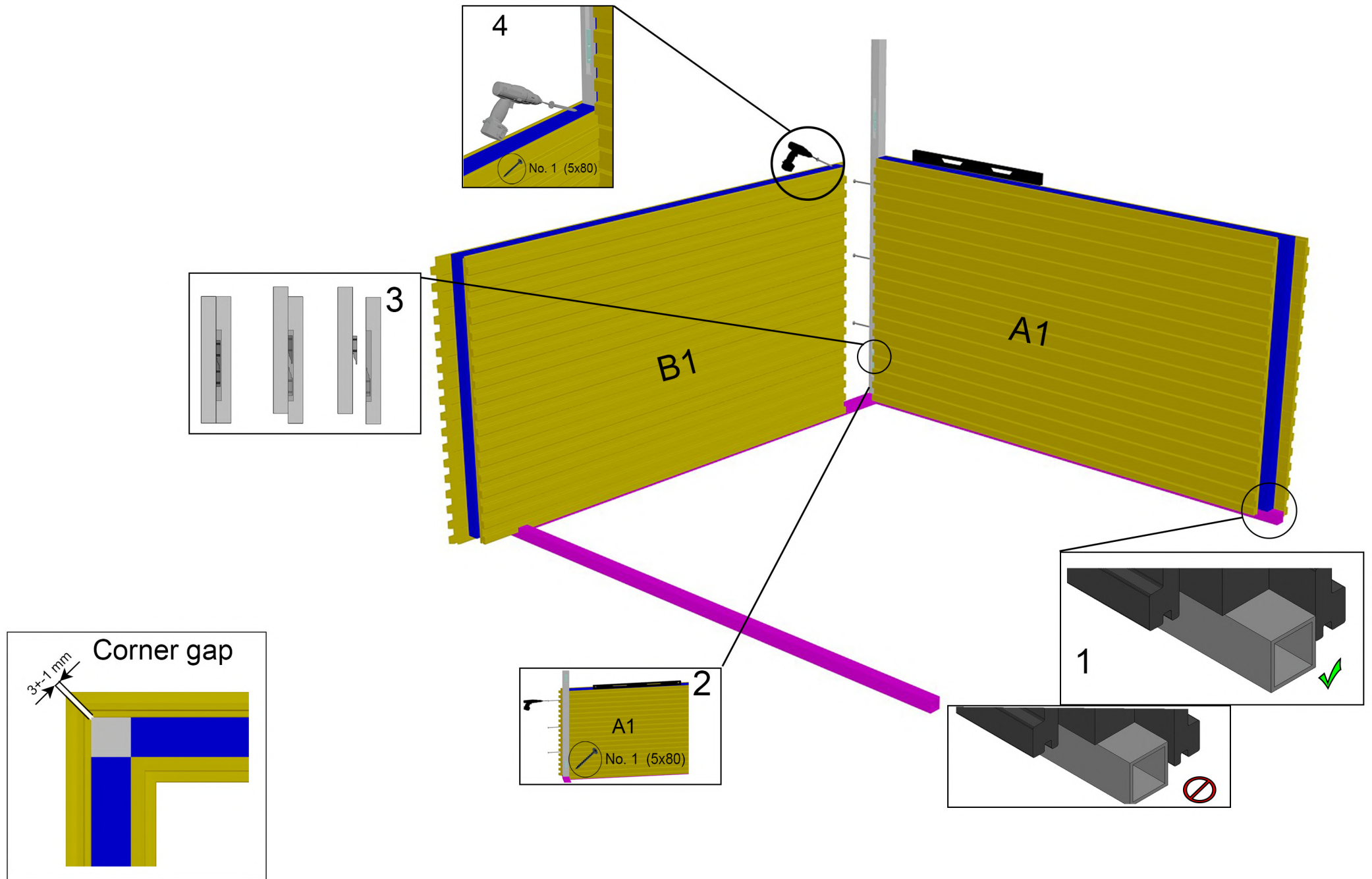

# 5. Fixing walls A2 & B2

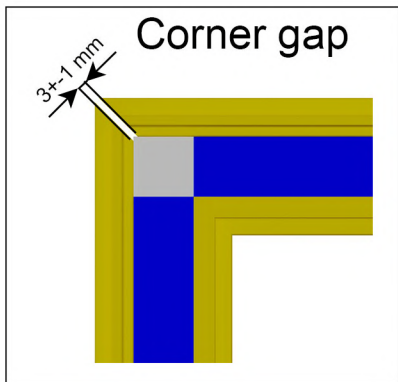
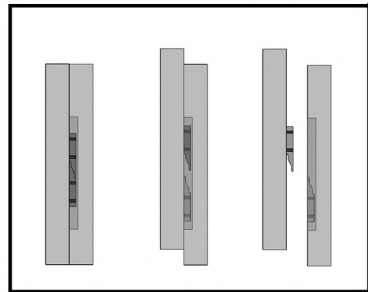
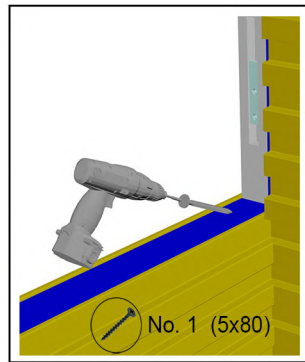
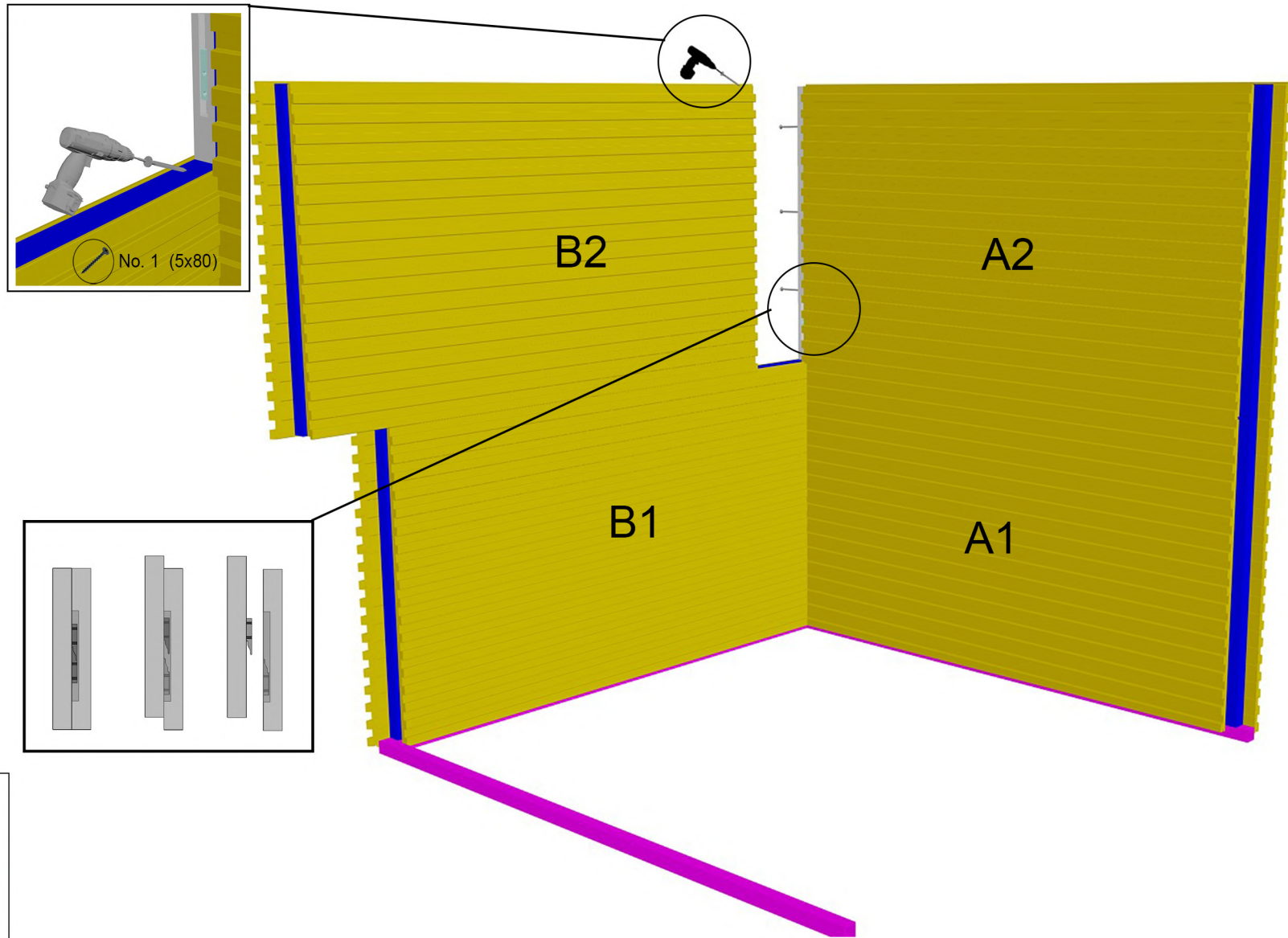



# 6. Fixing walls C1 & C2

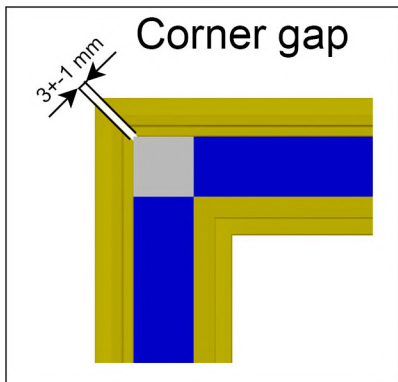
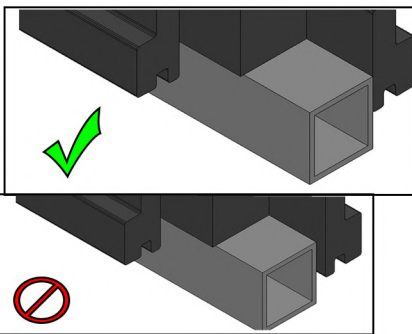
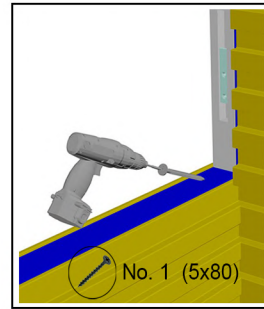
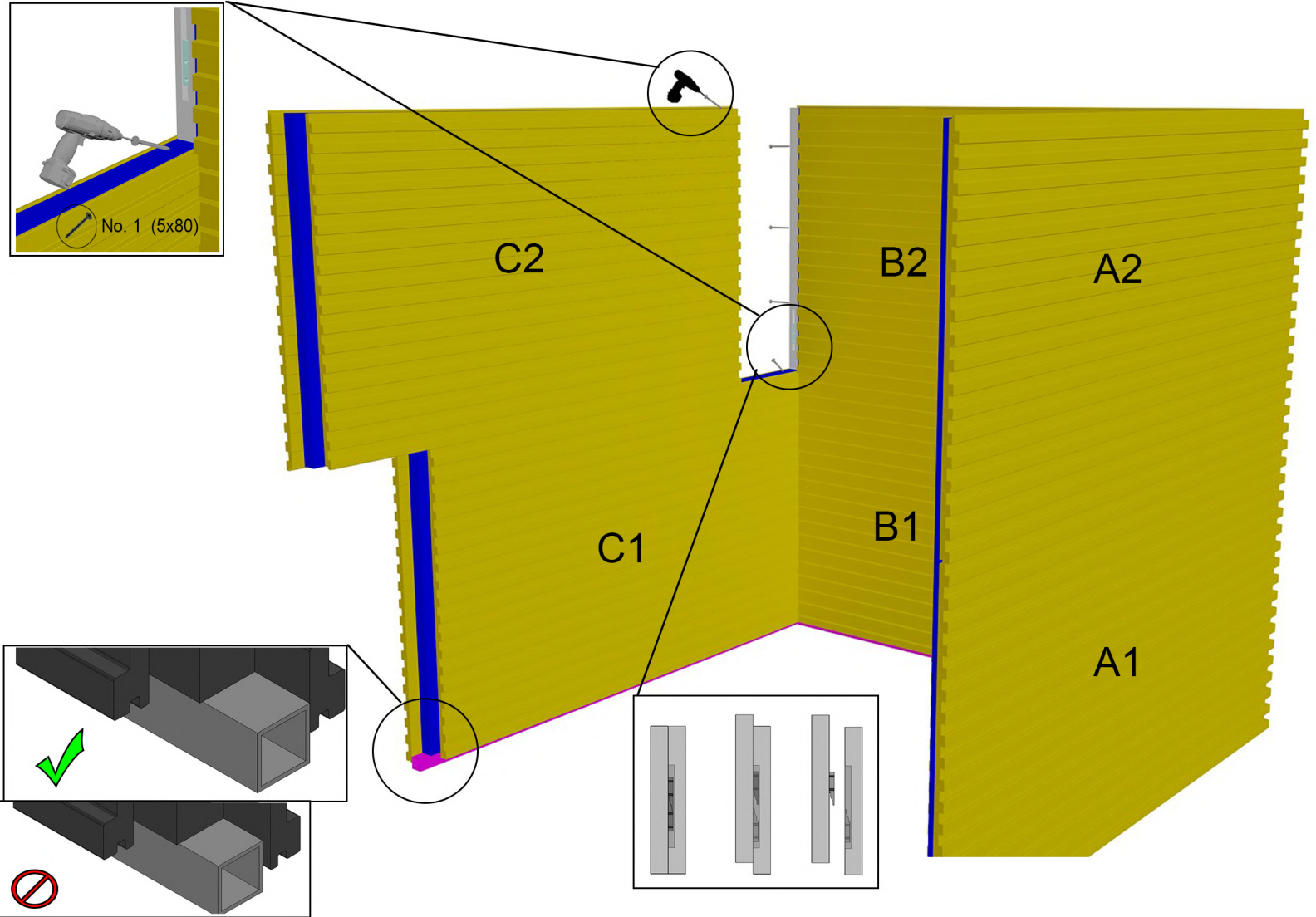

# 7. Fixing ceilings

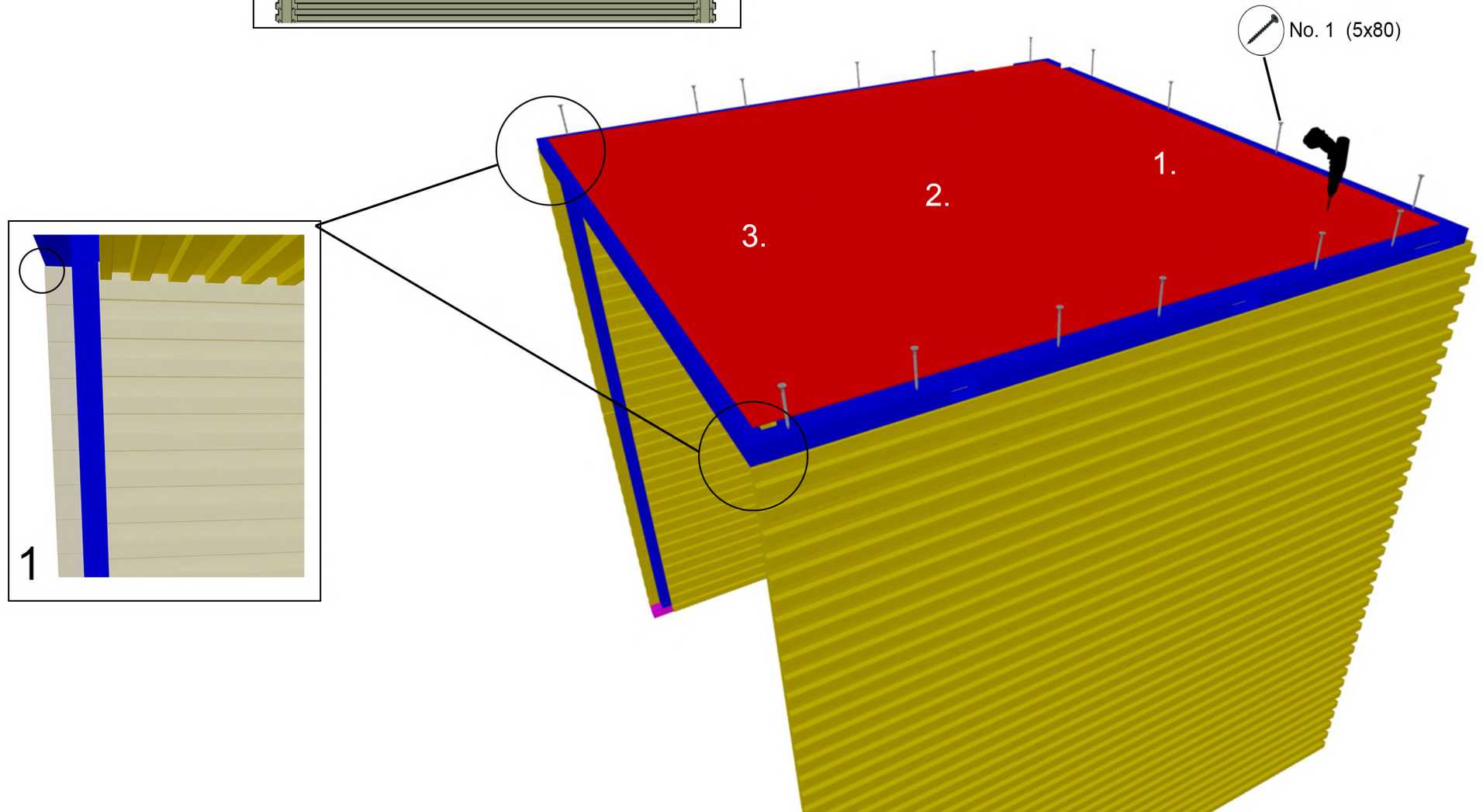
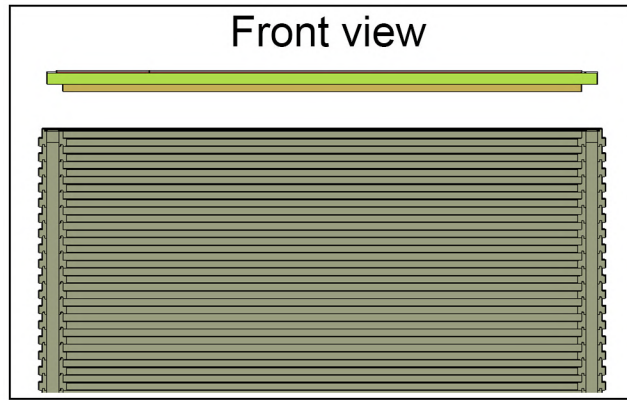

## 8. Interior 200x200 cm

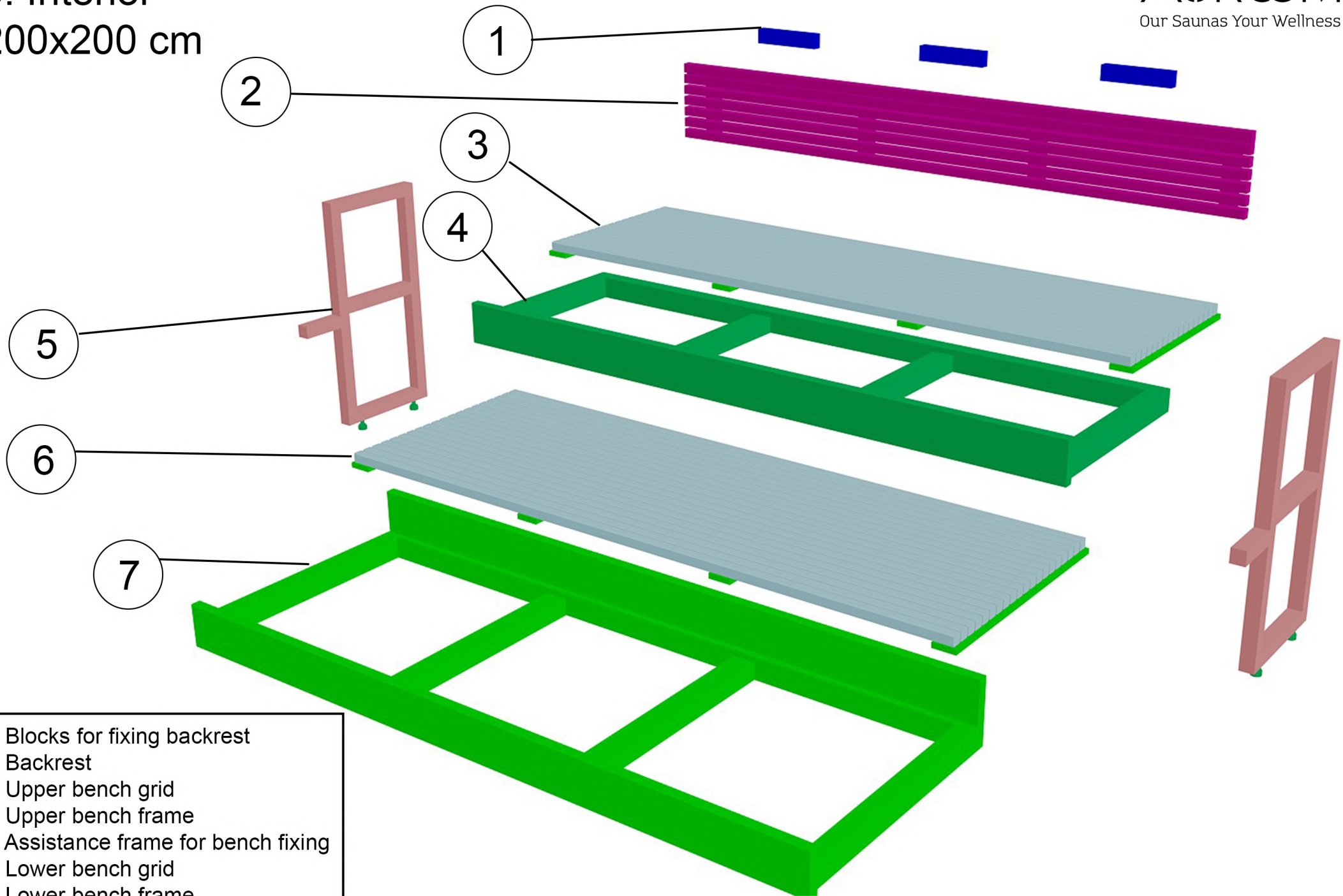

1. Blocks for fixing backrest
2. Backrest
3. Upper bench grid
4. Upper bench frame
5. Assistance frame for bench fixing
6. Lower bench grid
7. Lower bench frame

# 8.1 Interior 120x180 cm

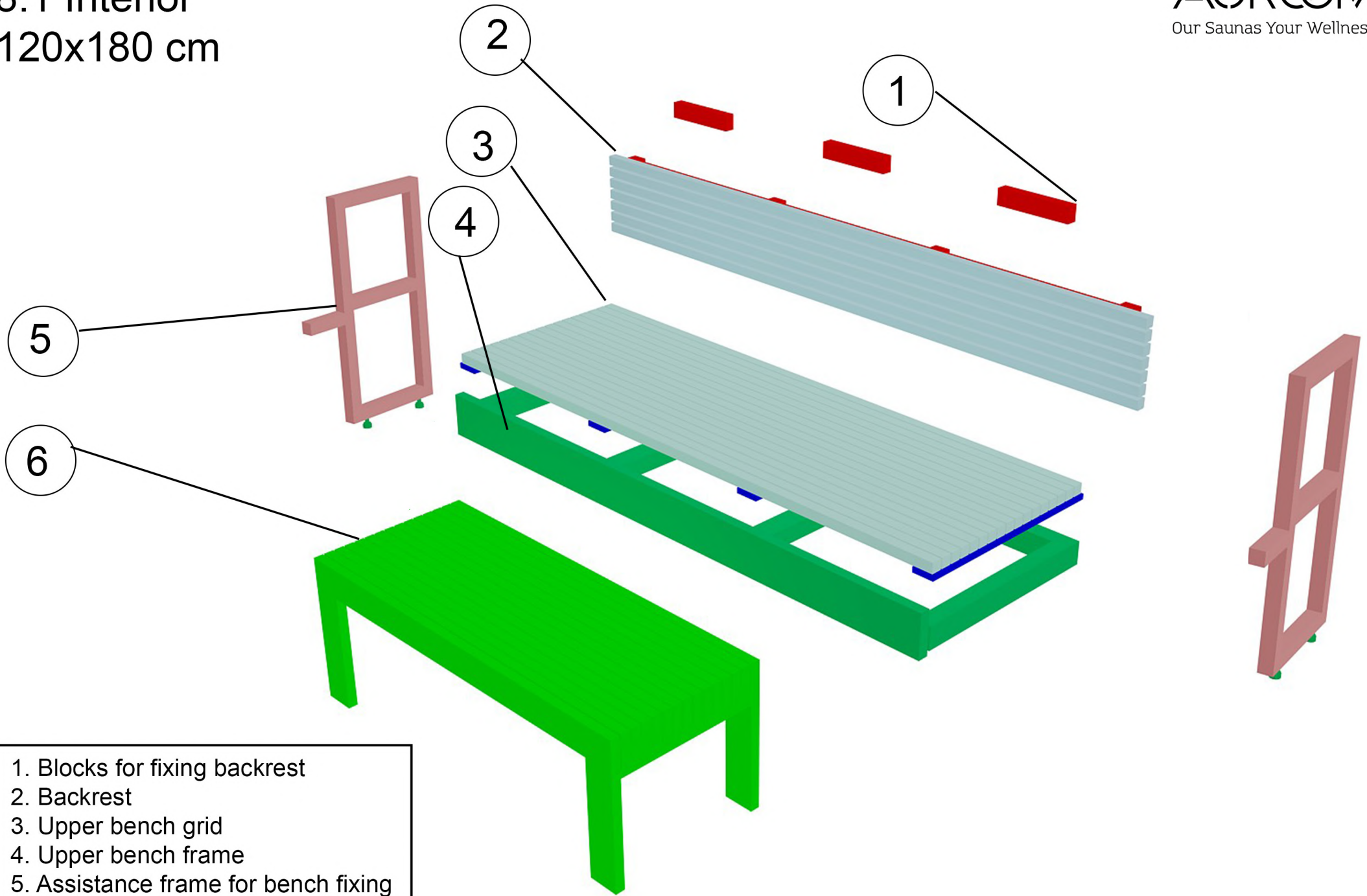

- 1. Blocks for fixing backrest
- 2. Backrest
- 3. Upper bench grid
- 4. Upper bench frame
- 5. Assistance frame for bench fixing
- 6. Lower bench

## 8.2 Interior

150x180 cm  
150x200 cm

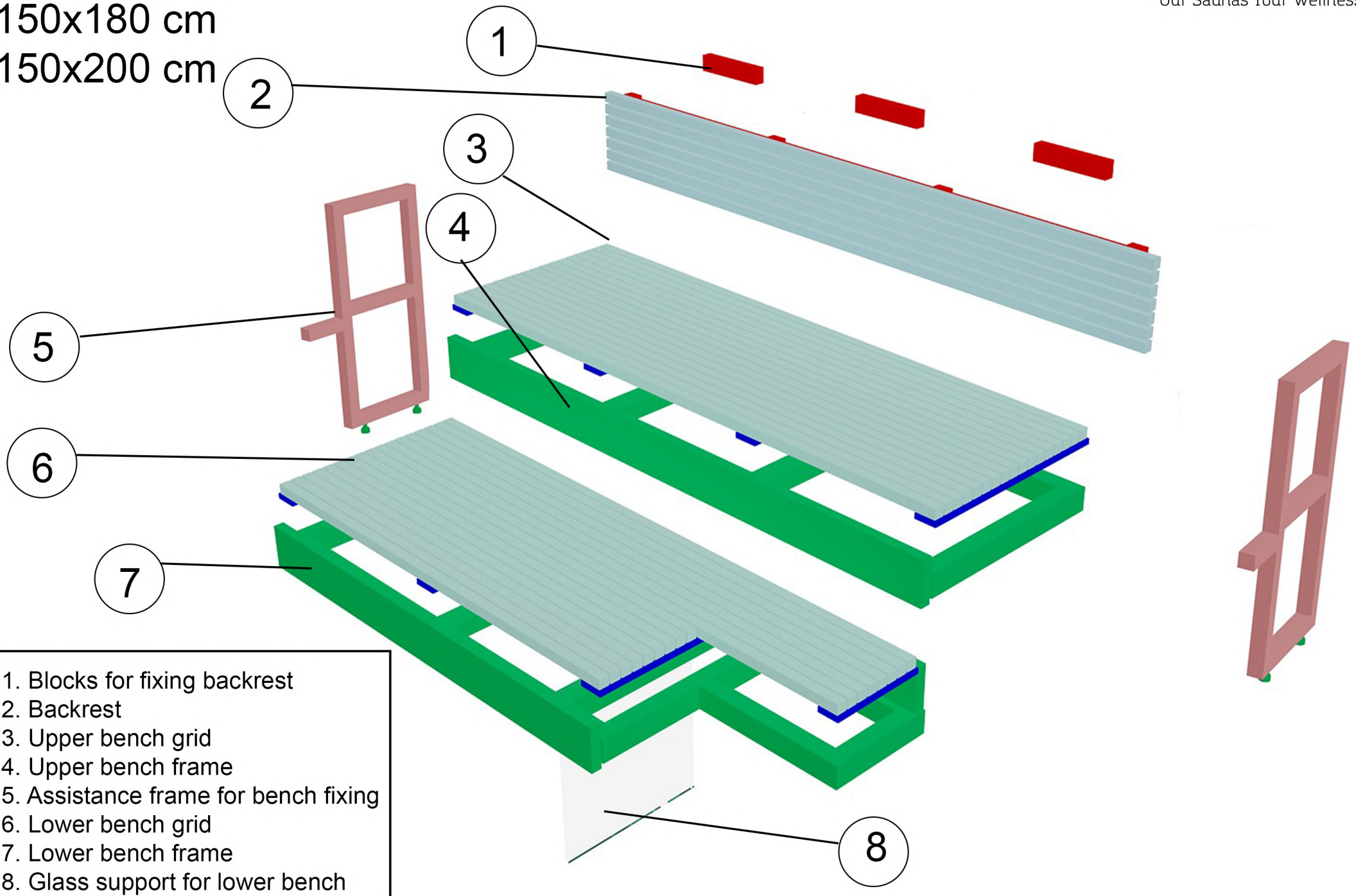

## 8.3 Interior 200x250 cm

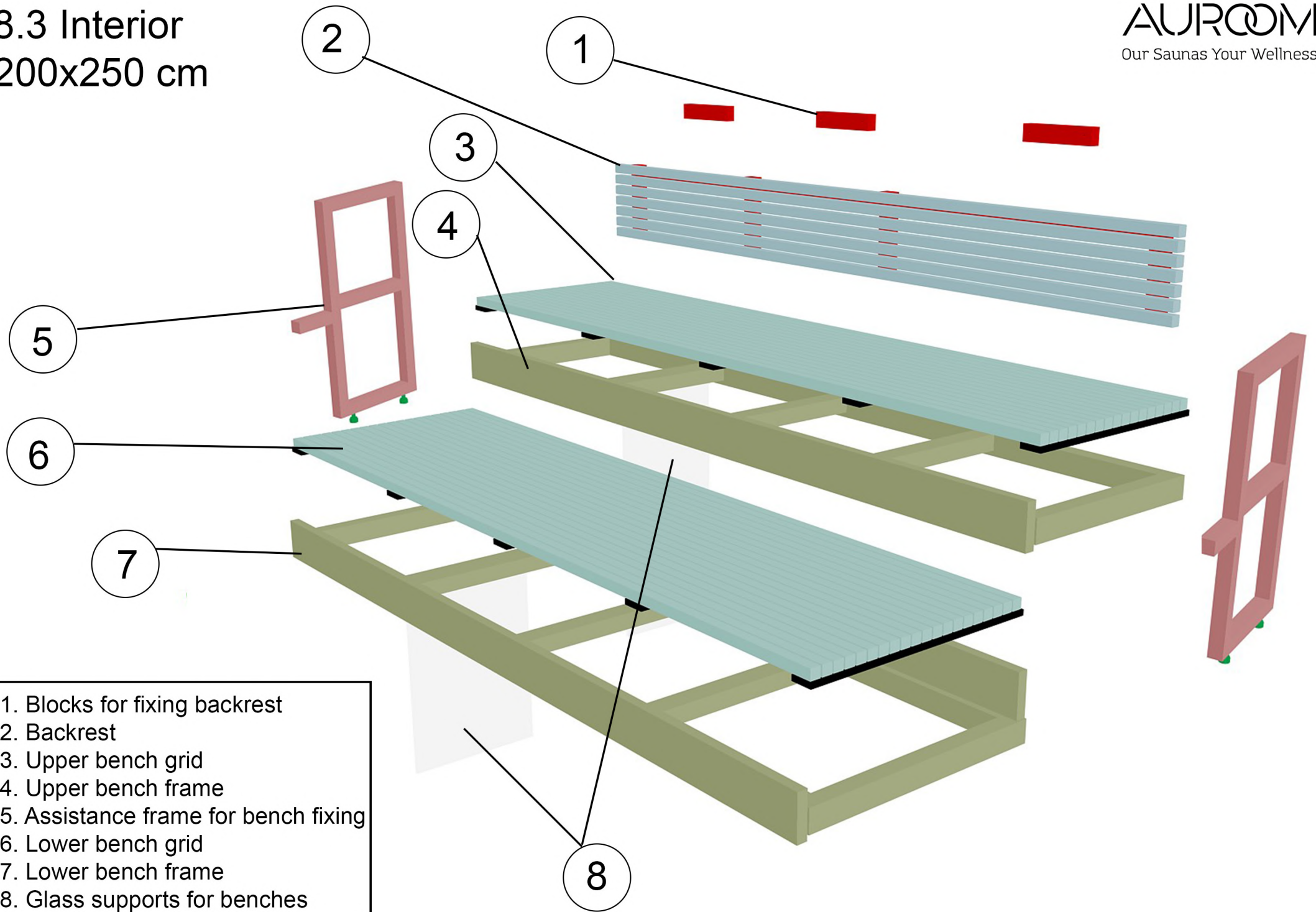

1. Blocks for fixing backrest
2. Backrest
3. Upper bench grid
4. Upper bench frame
5. Assistance frame for bench fixing
6. Lower bench grid
7. Lower bench frame
8. Glass supports for benches

# 9. Assistance frames

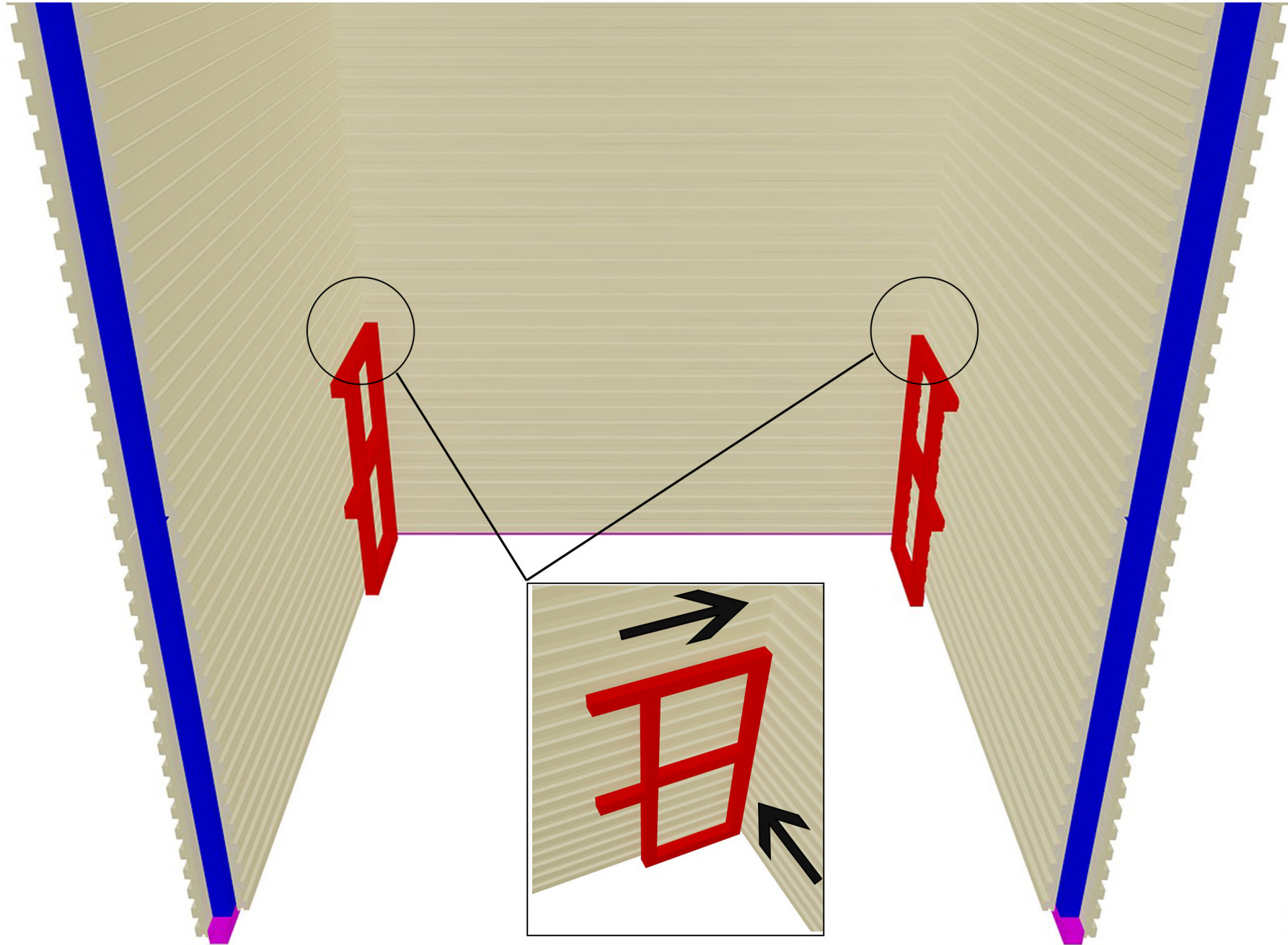

# 10. Bench frames and backrest blocks

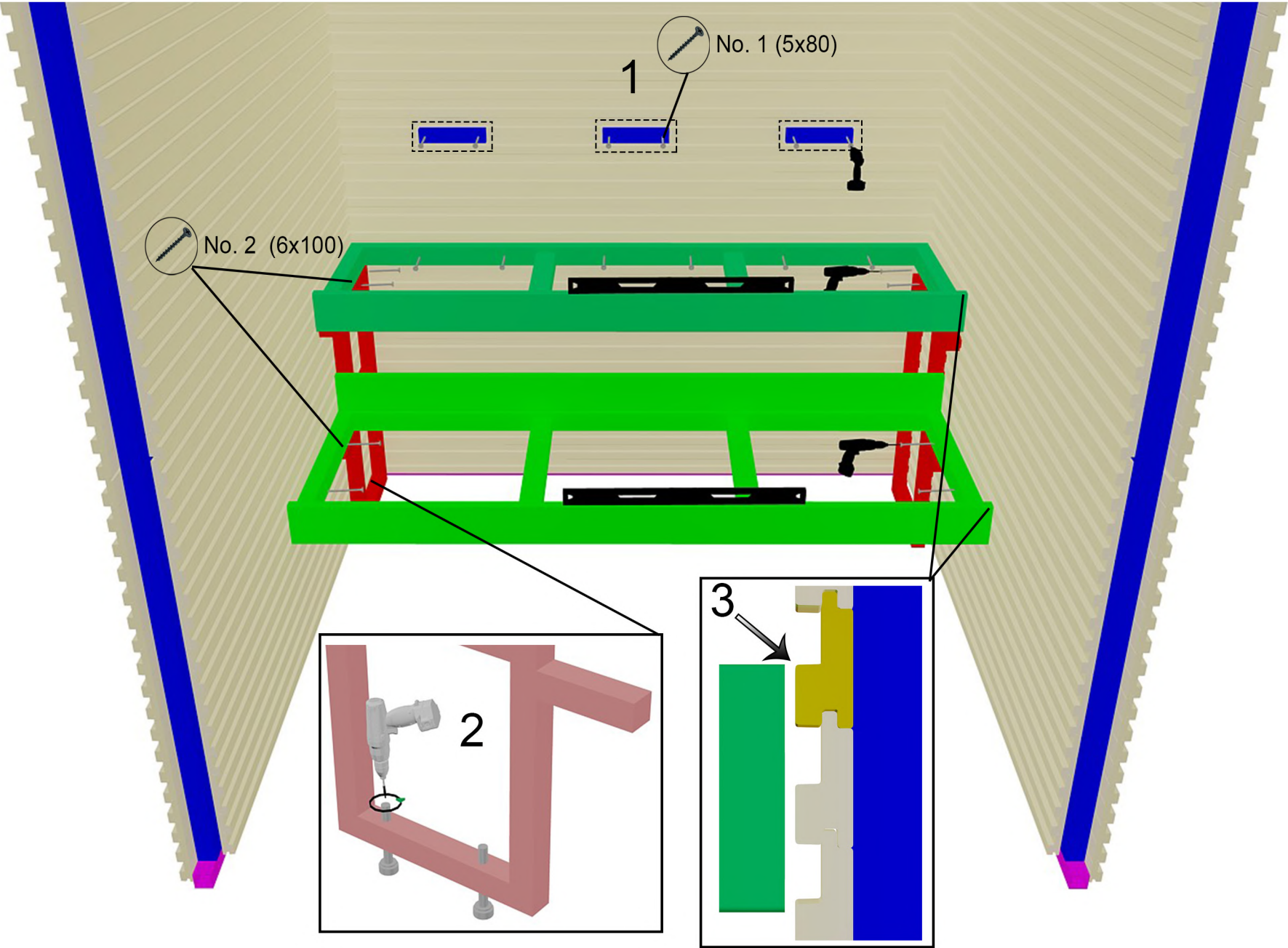



# 11. Removing assistance frames

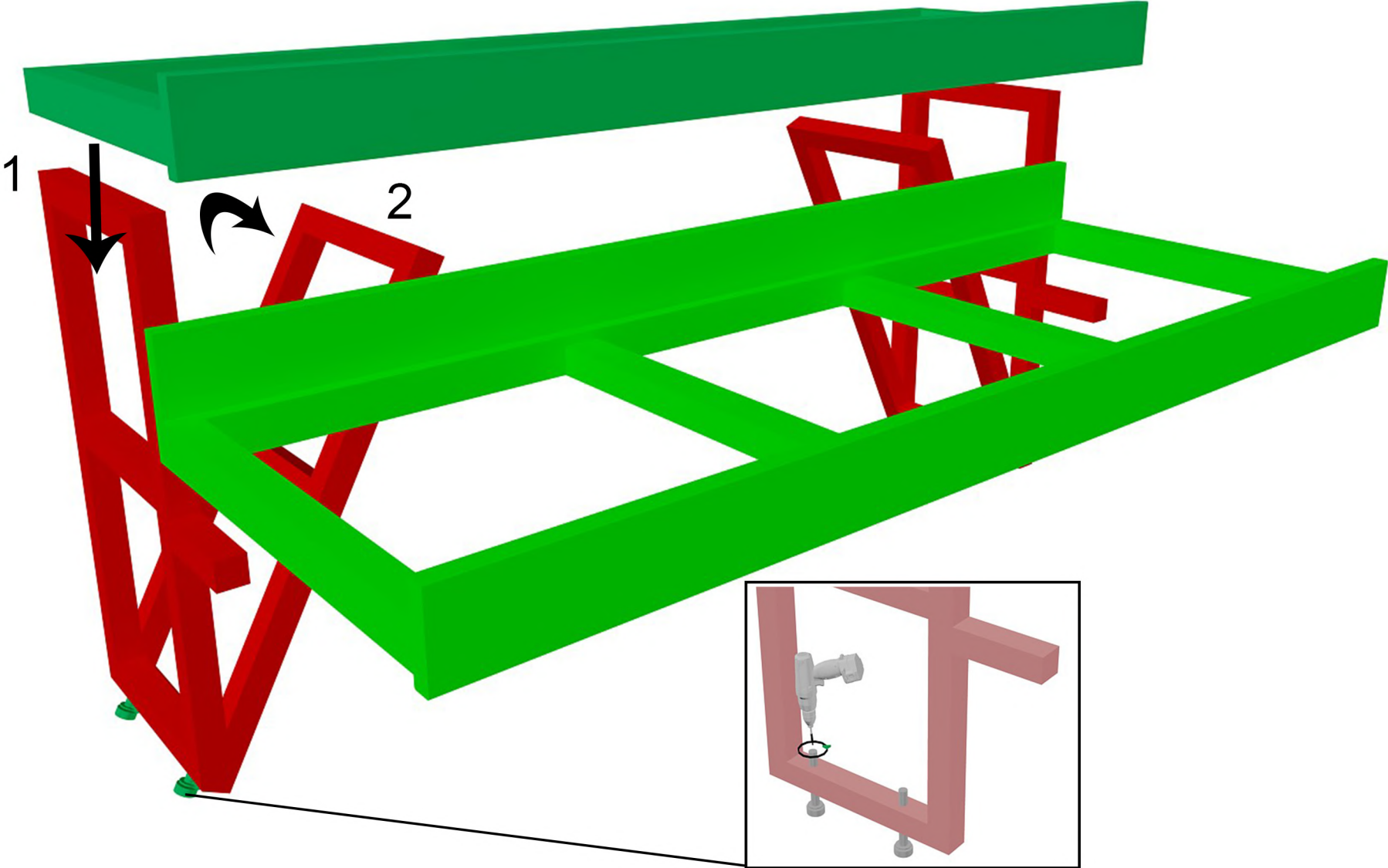

## 12. Wiring inside walls

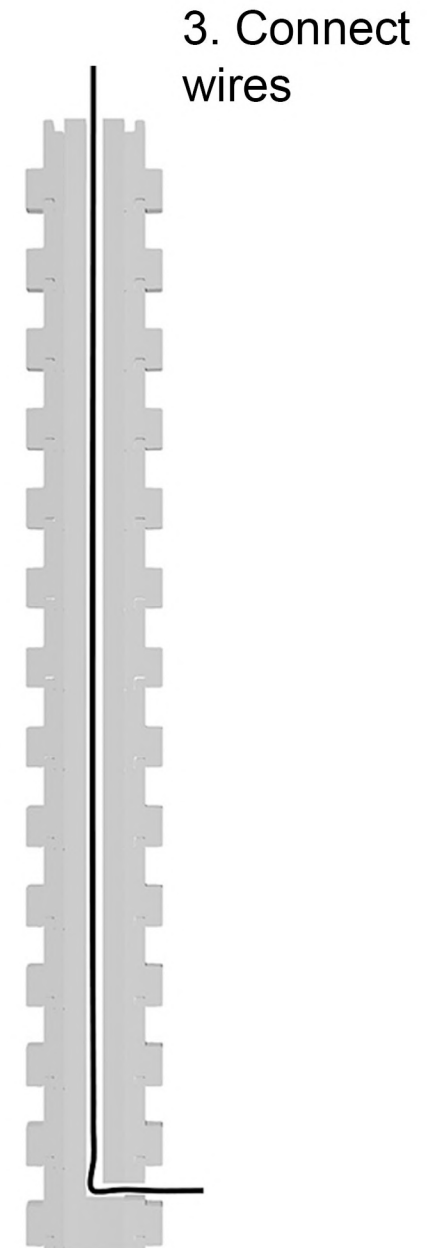
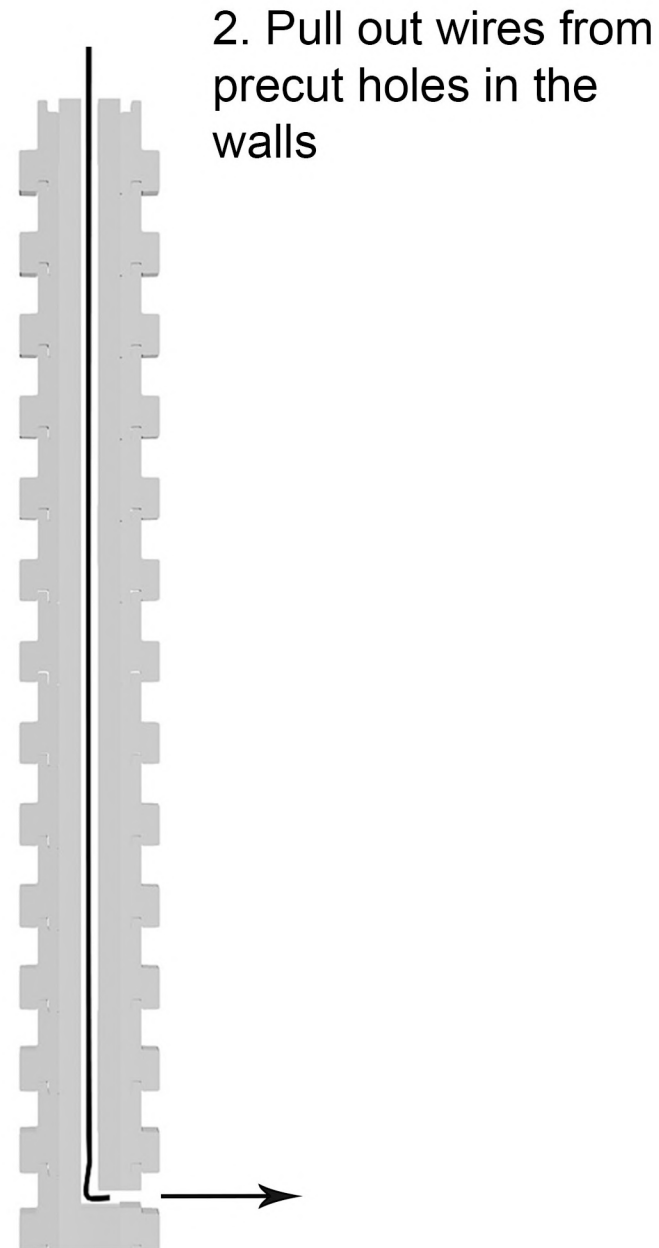
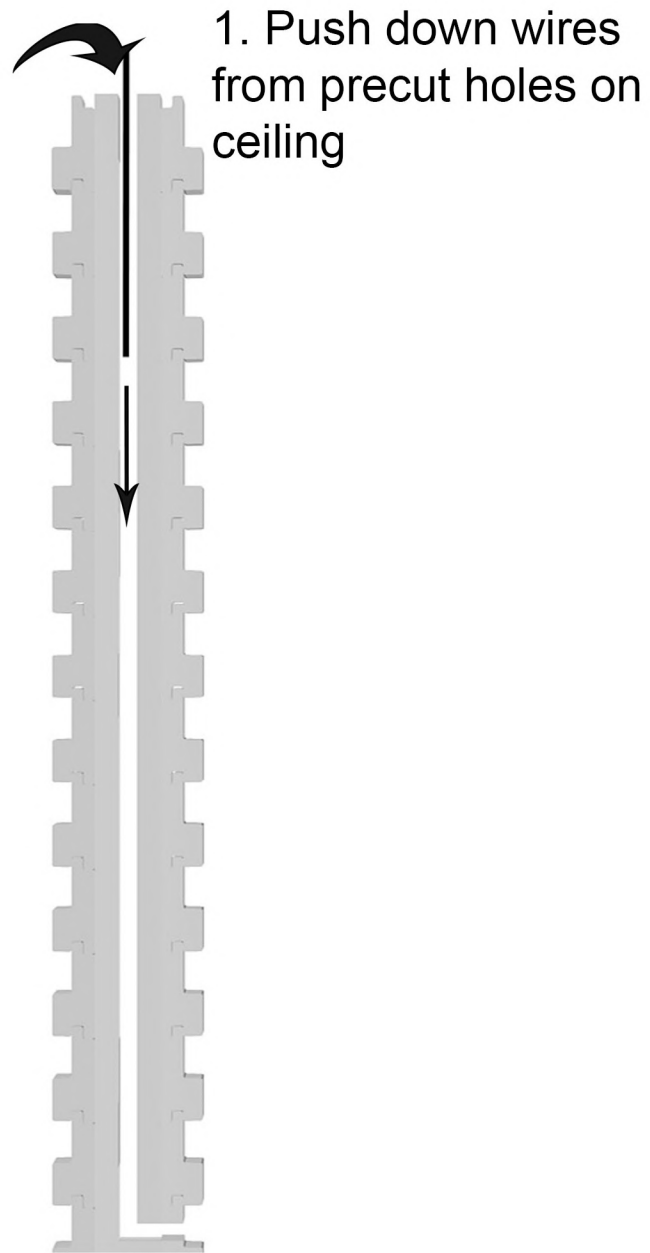

# 13. LED-strip connections

! Always use certified electrician

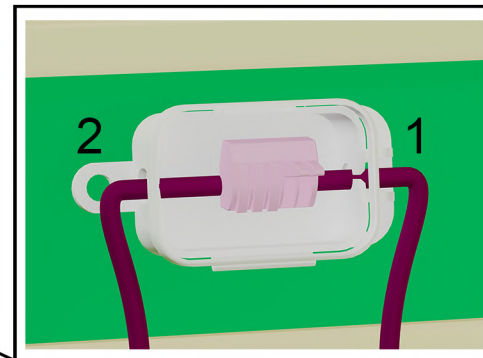
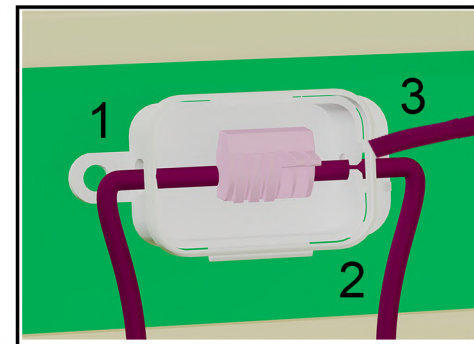
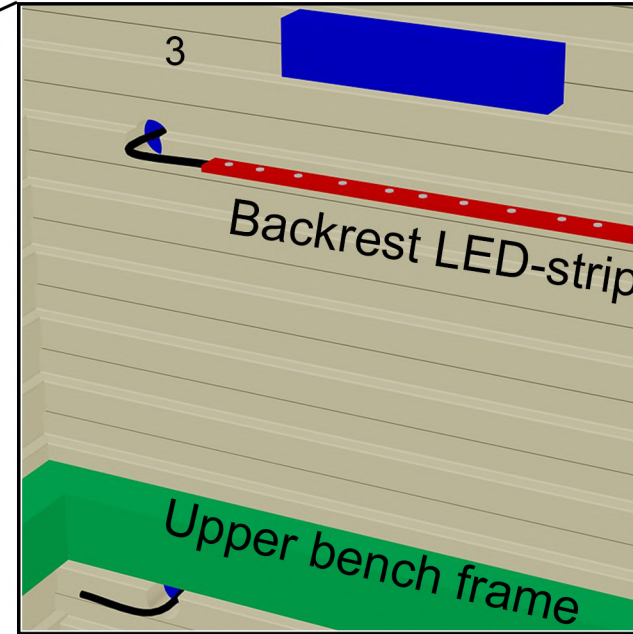
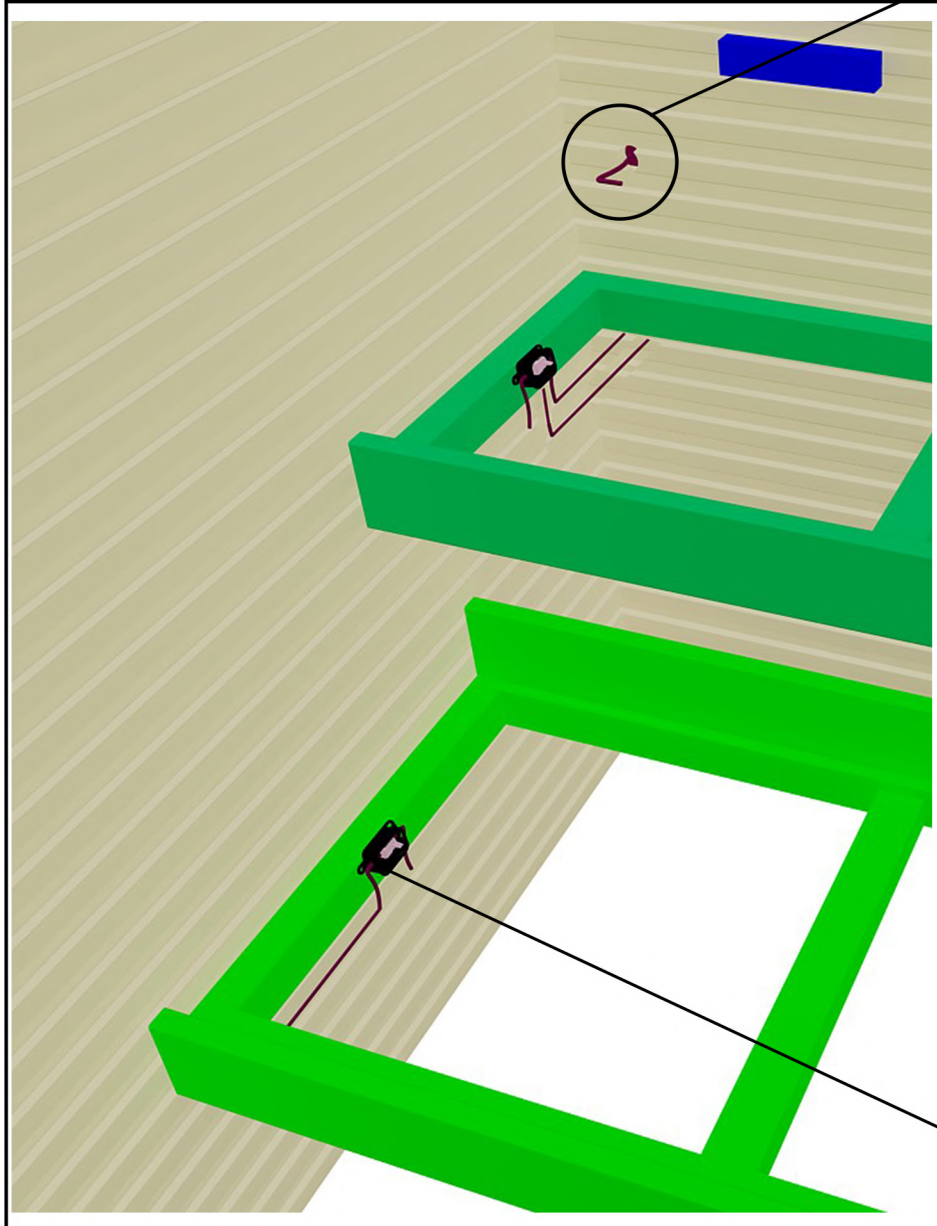

- 1. Wires from the ceiling
- 2. Bench LED-strip wires
- 3. Backrest LED-strip wire

# 14. Backrest & bench grids

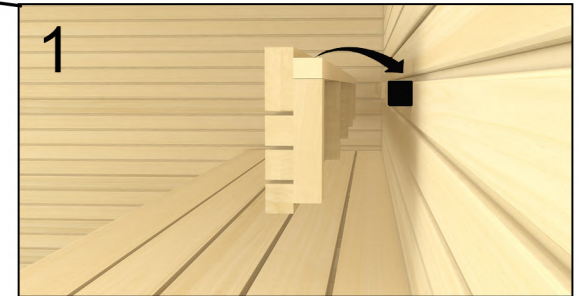
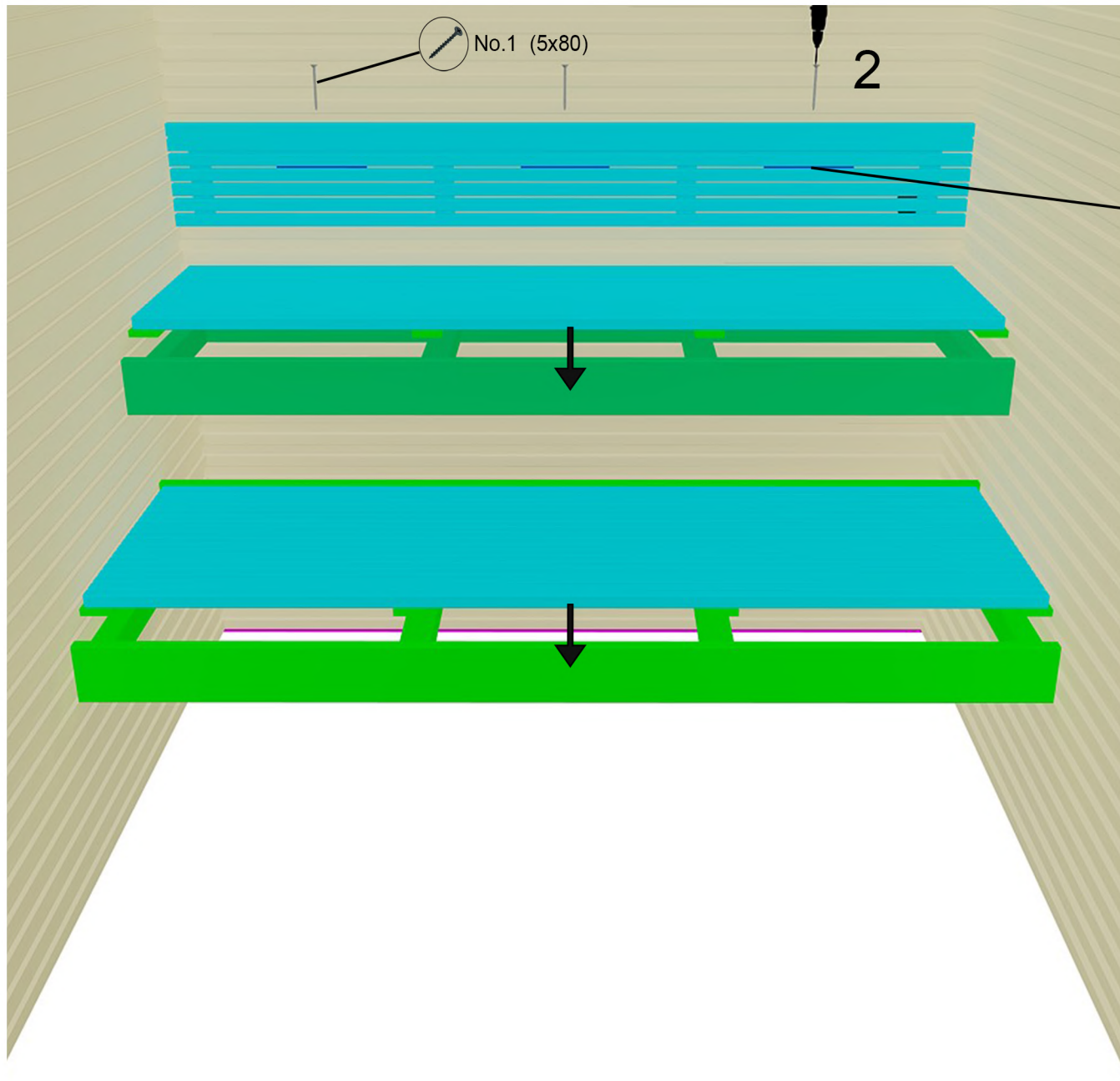

3. Fix LED-strip on top of backrest with glue (covers screws)

# 14.1 Fixing glass supports

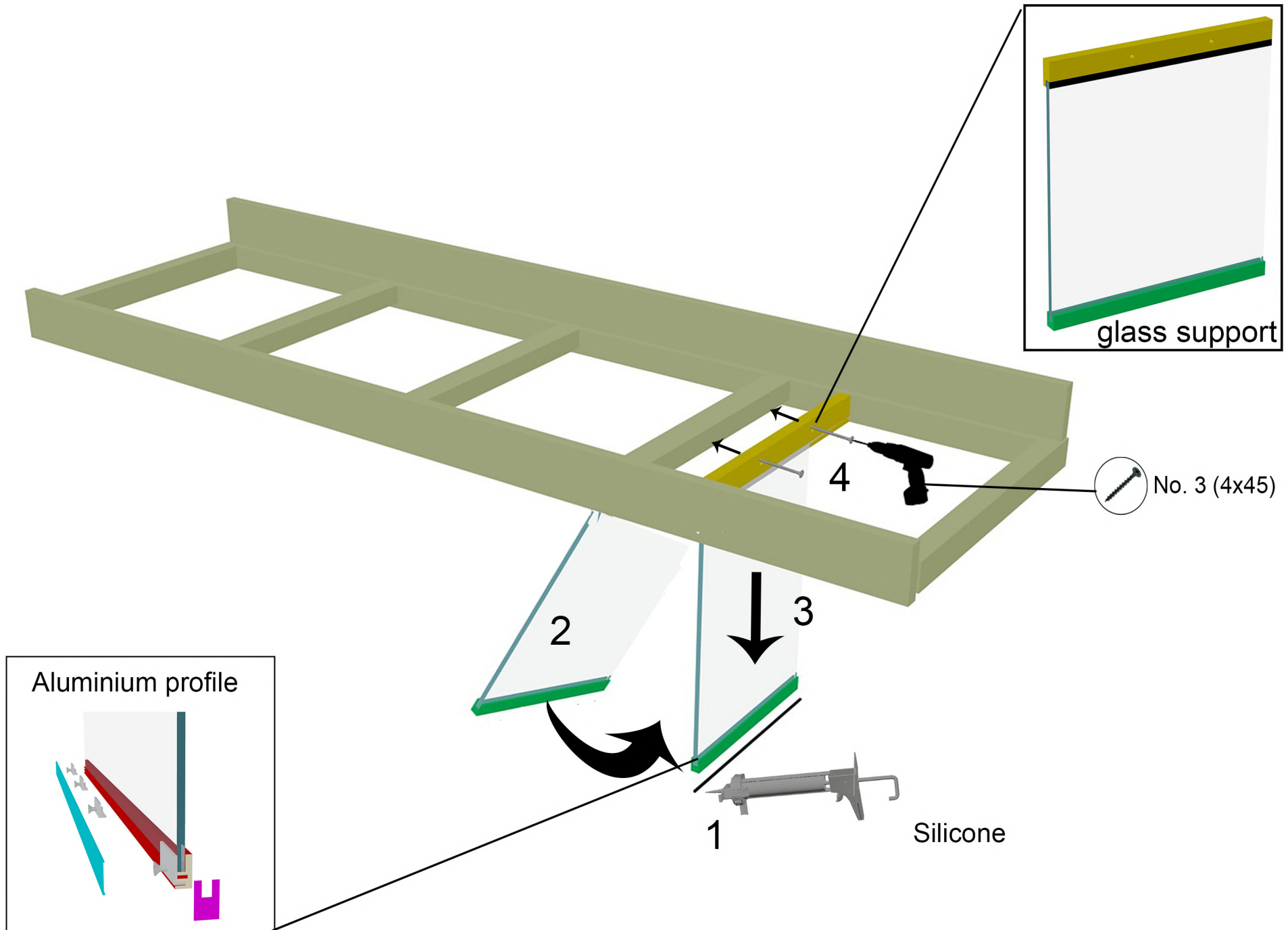

# 15. Interior II

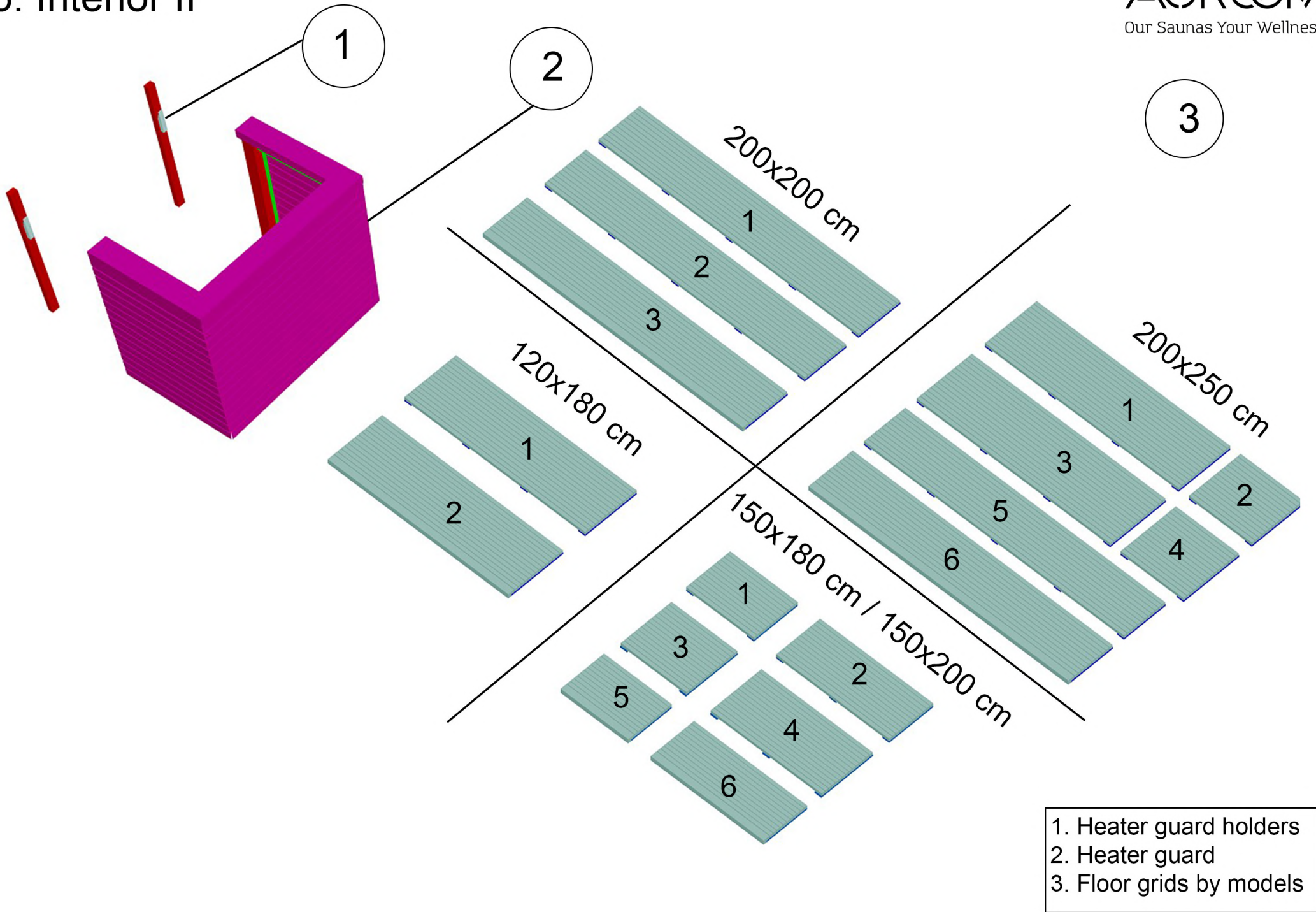

# 16. Heater guard

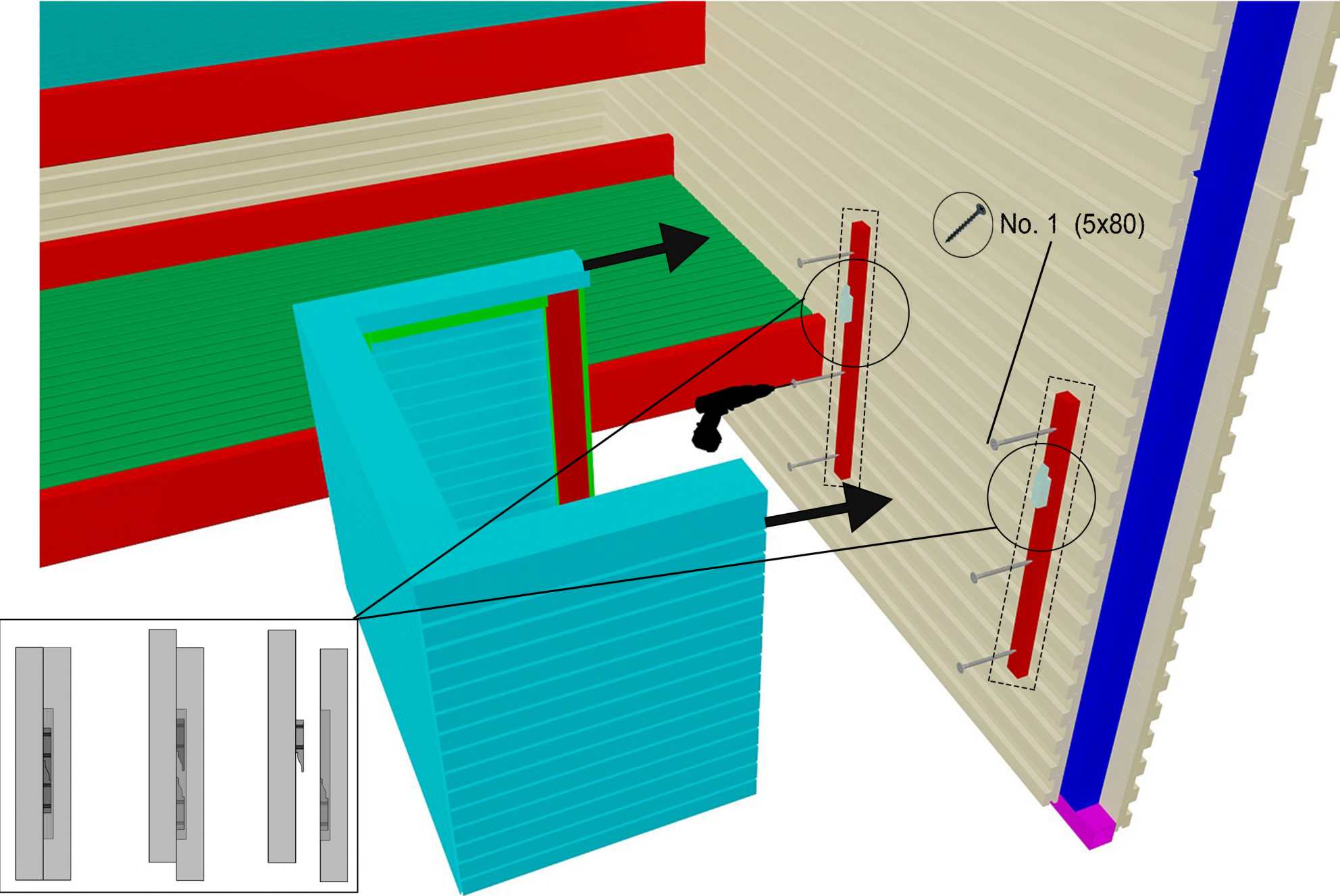

# 17. Door and glass wall

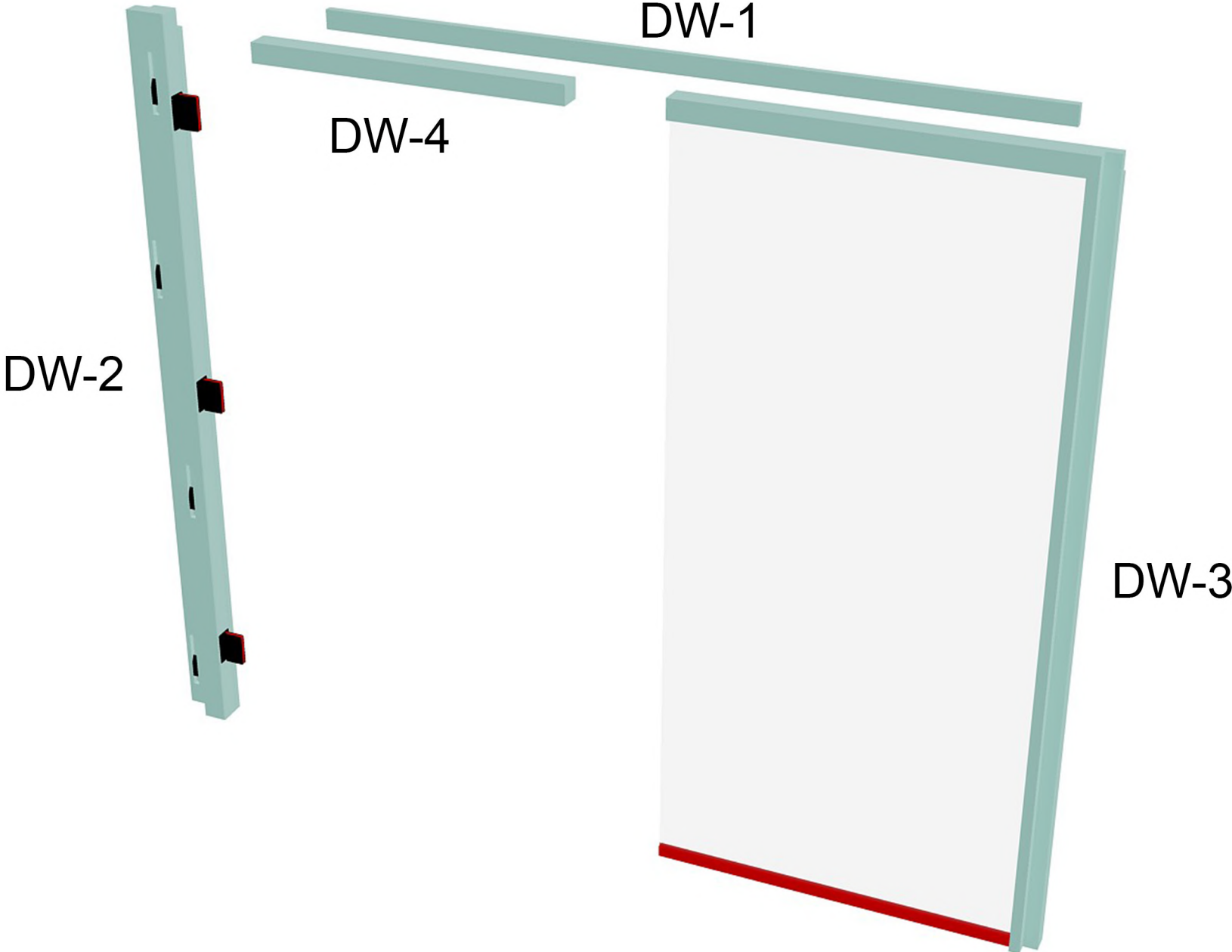



# 18. Fixing door & glass wall frame

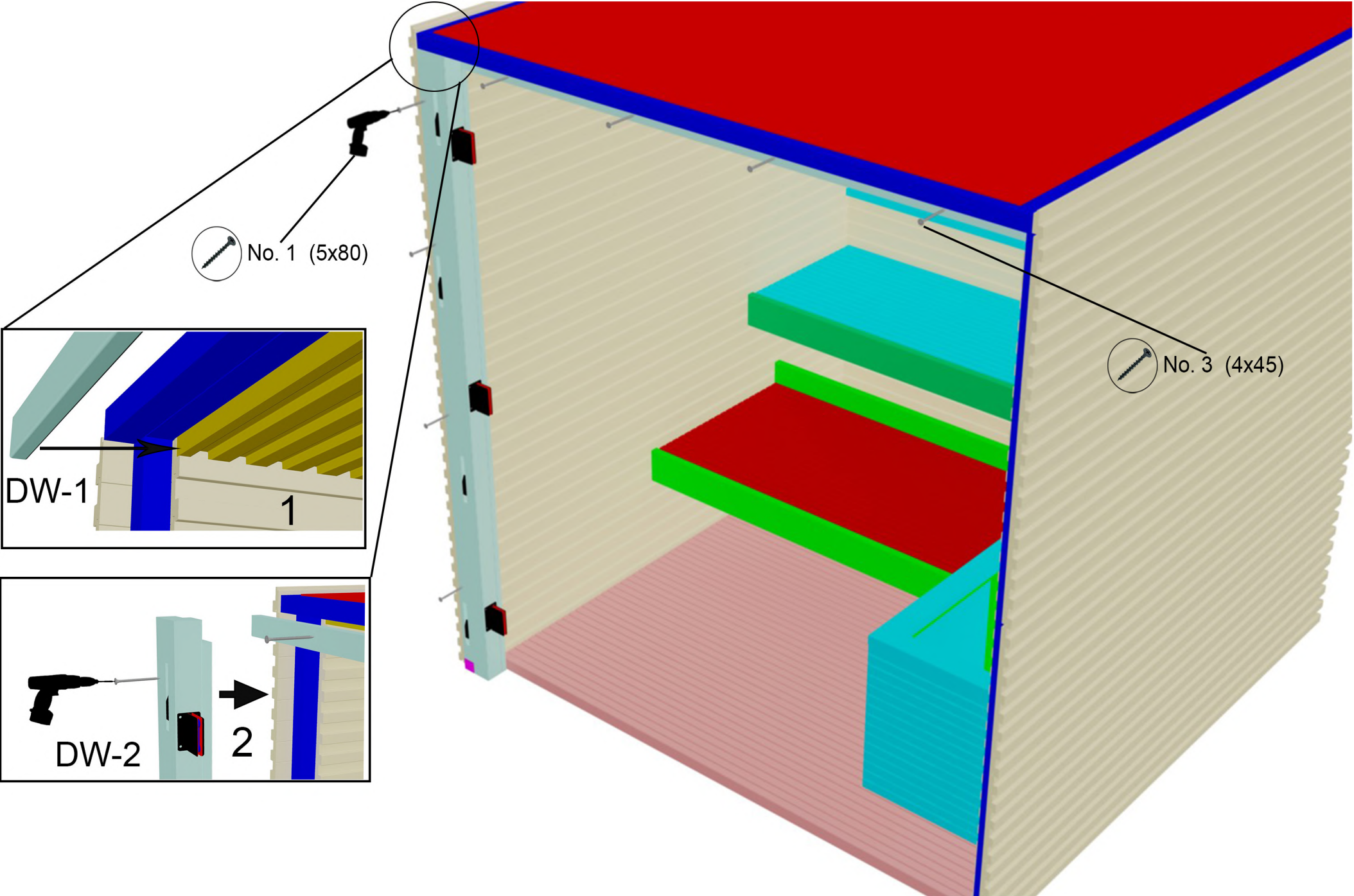

# 19. Aluminium profile fixing under glass wall

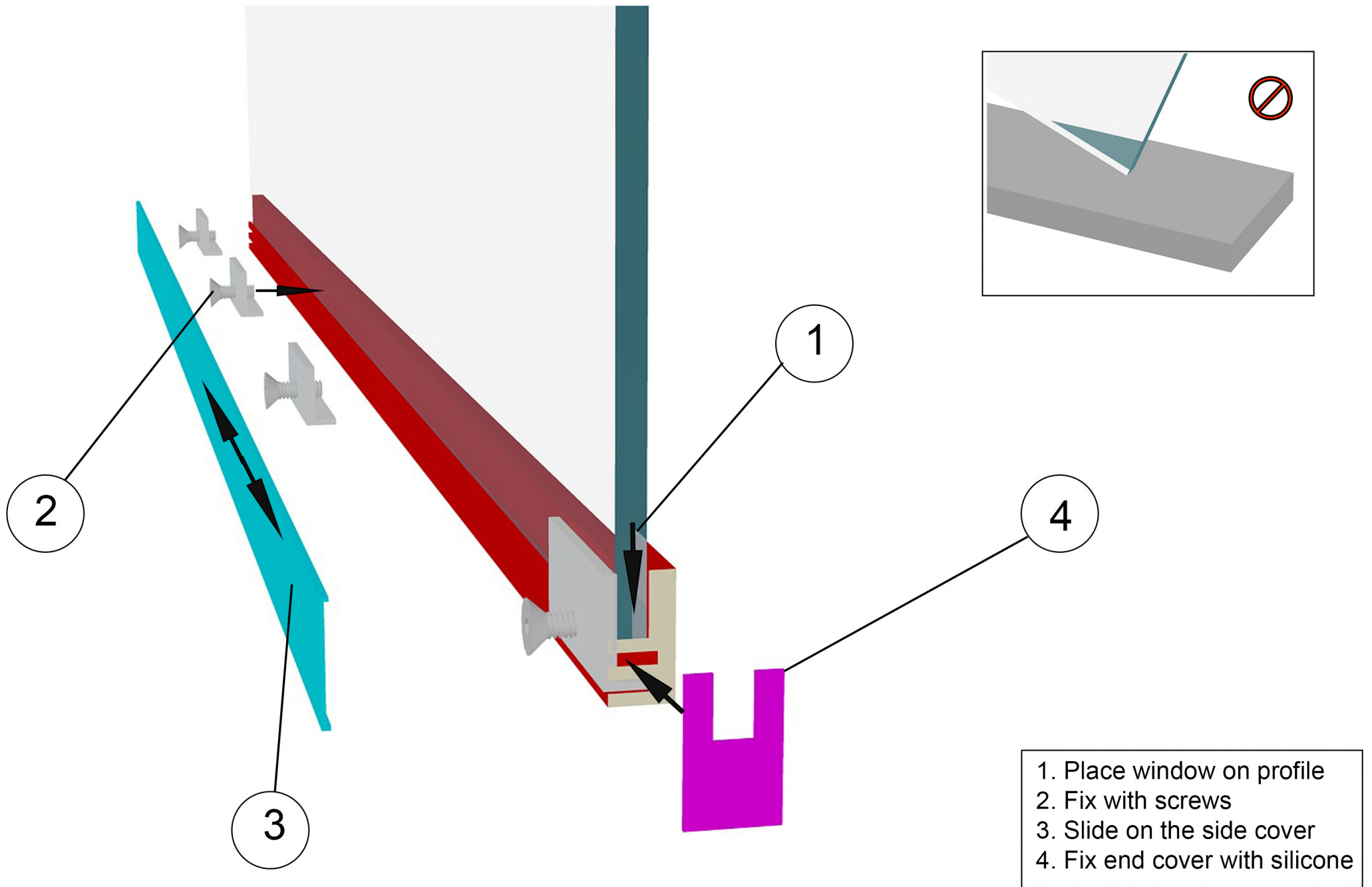

# 20. Fixing door & glass wall frame

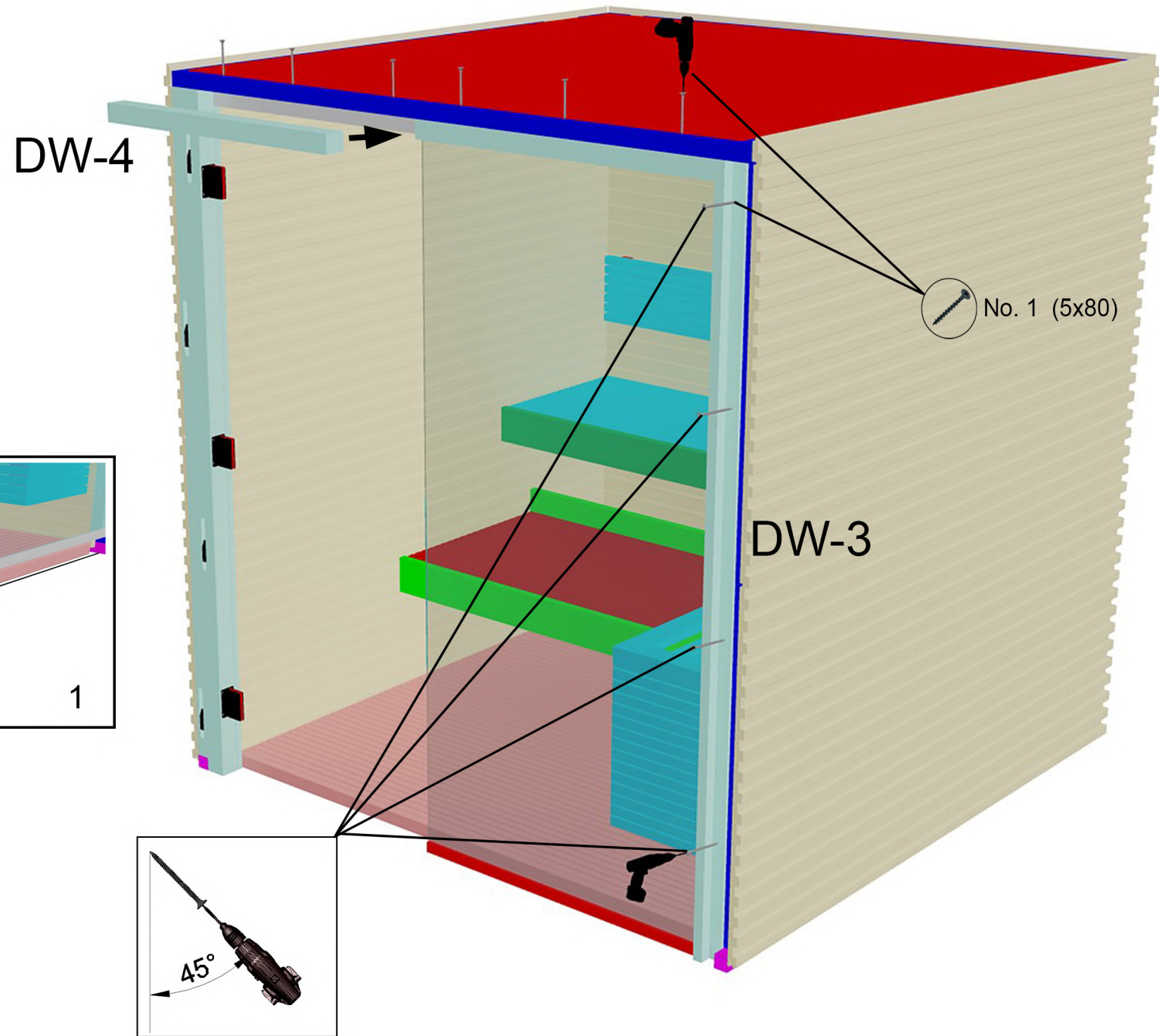

# 21. Adjusting glass wall

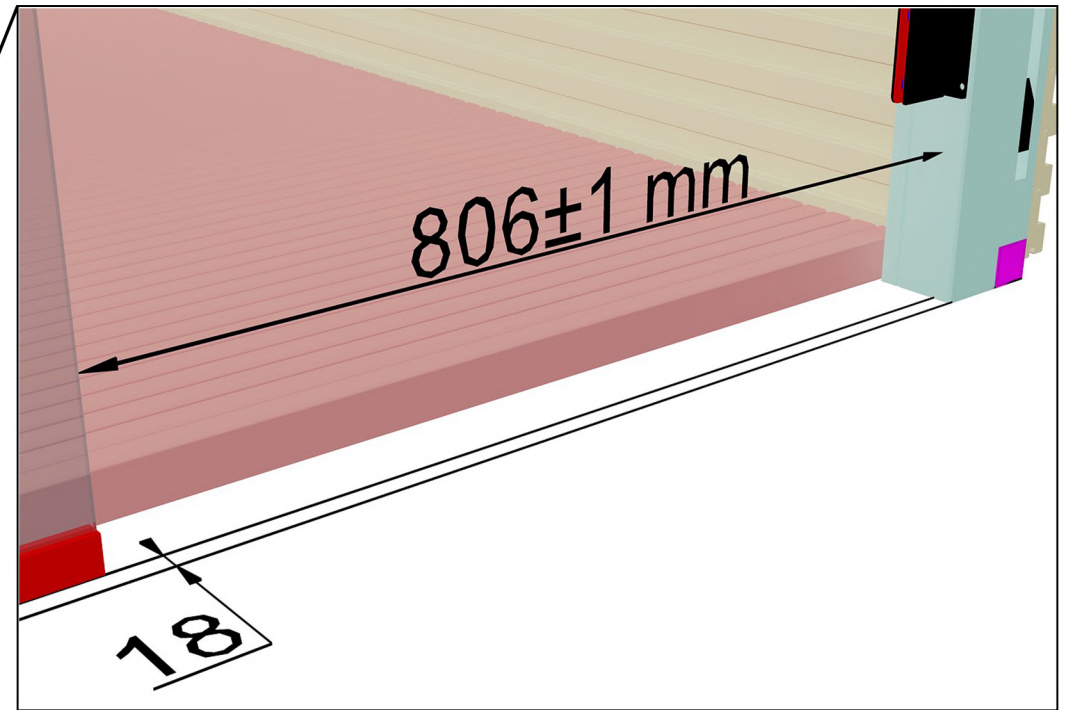
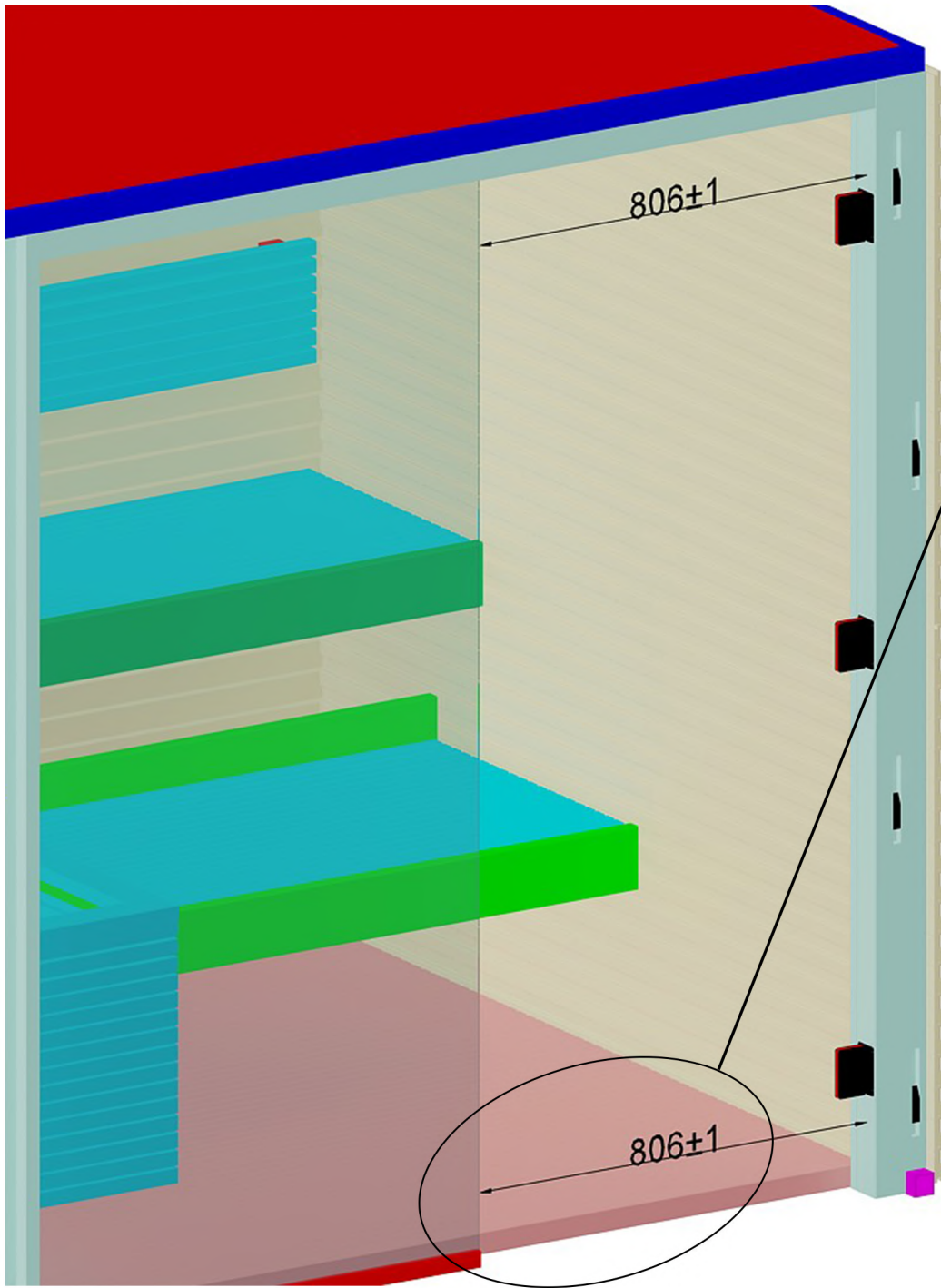

## 22. Fixing Detail 1

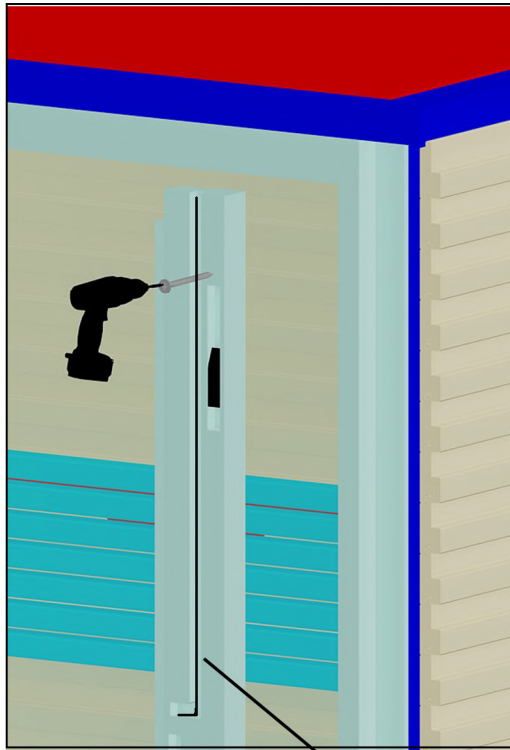

1

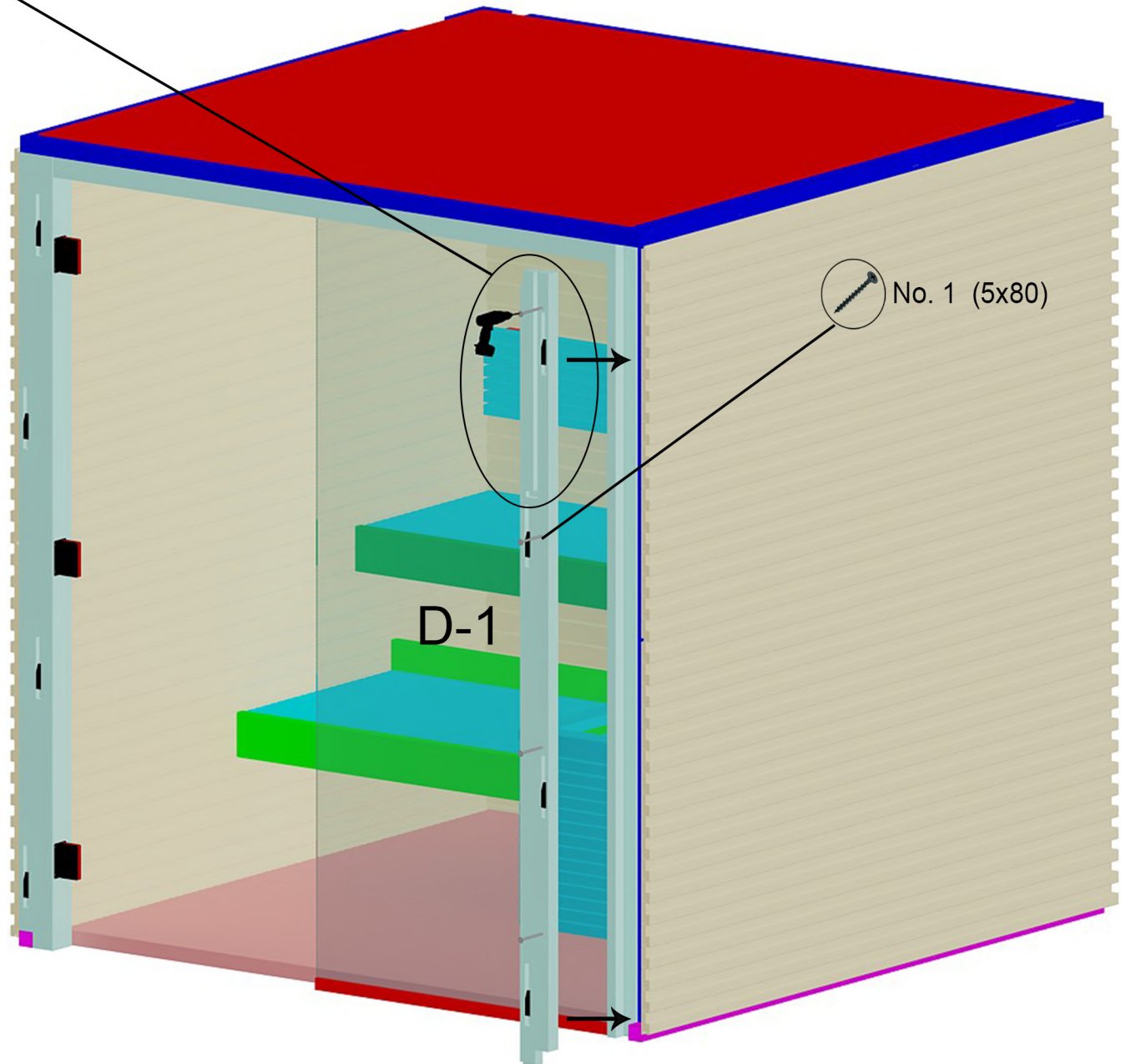

No. 1 (5x80)

D-1

1. Cut out for  
control unit cable

## 23. Upper frame

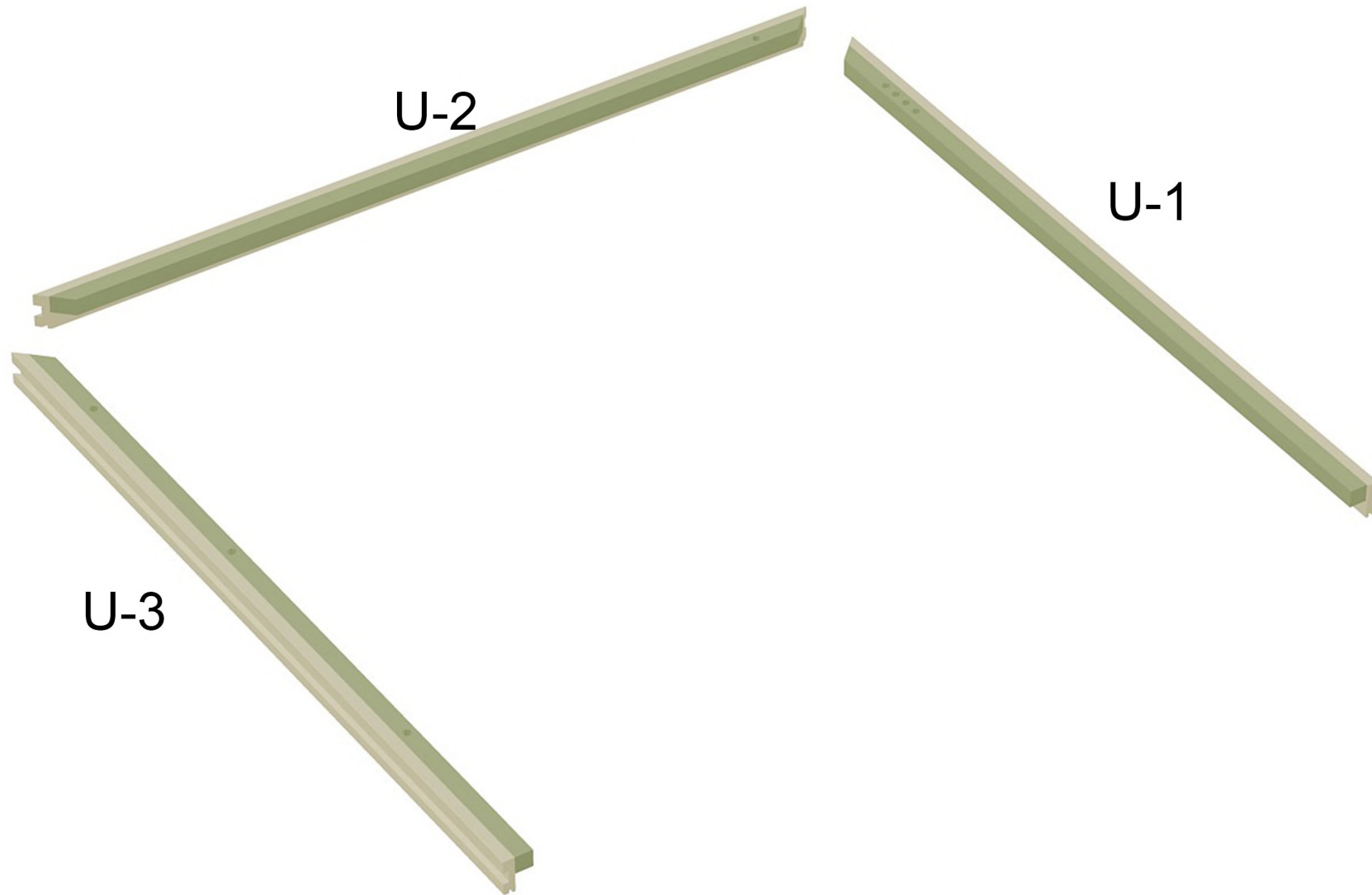

## 24. Fixing upper frame

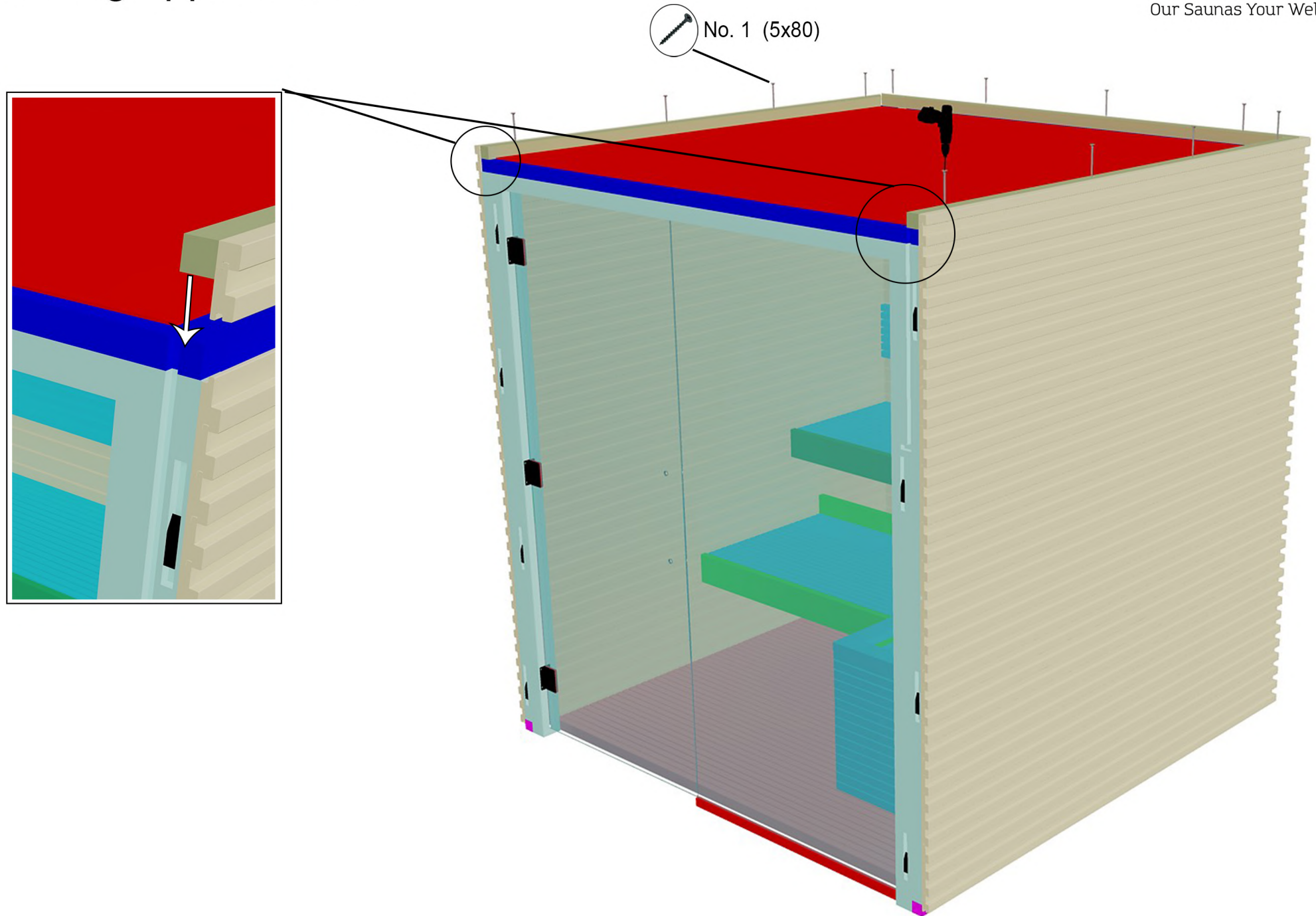

# 25. Door hinges and handle

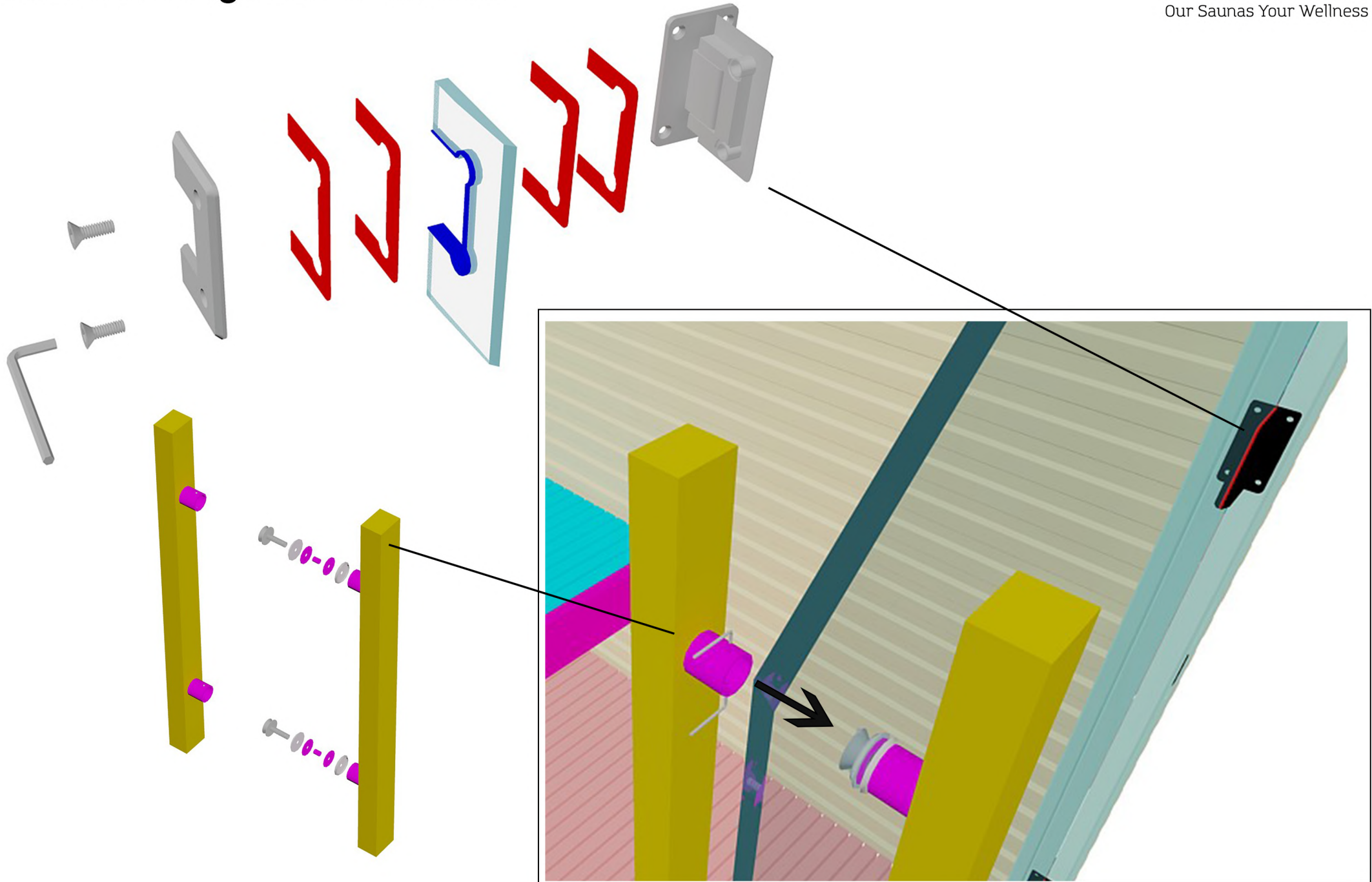



## 26. Control unit cable mounting

FF-1

3

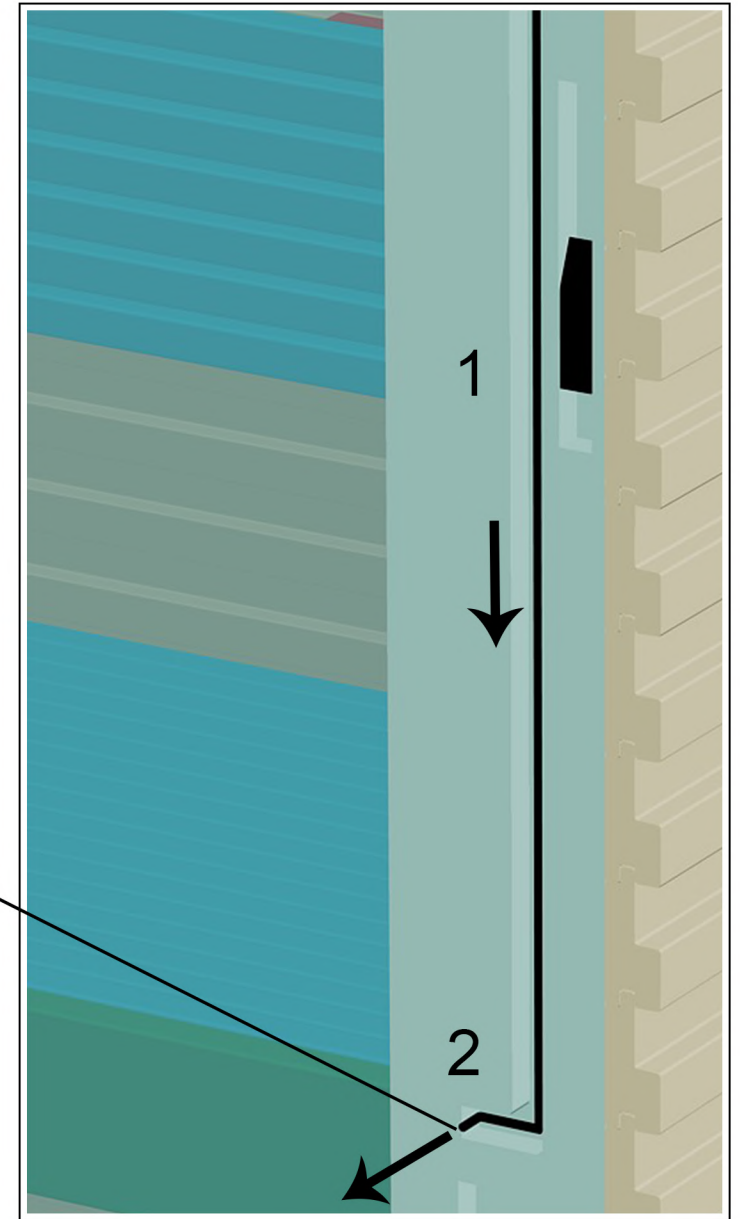
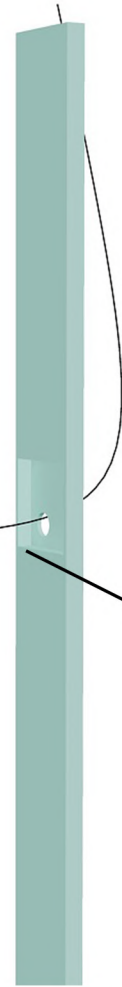

1. Put control unit cable inside (D-1) precut
2. Make sure cable stays in precut and install front frame detail (FF-1)
3. Pull out cable from hole in front frame

# 27. Front frame

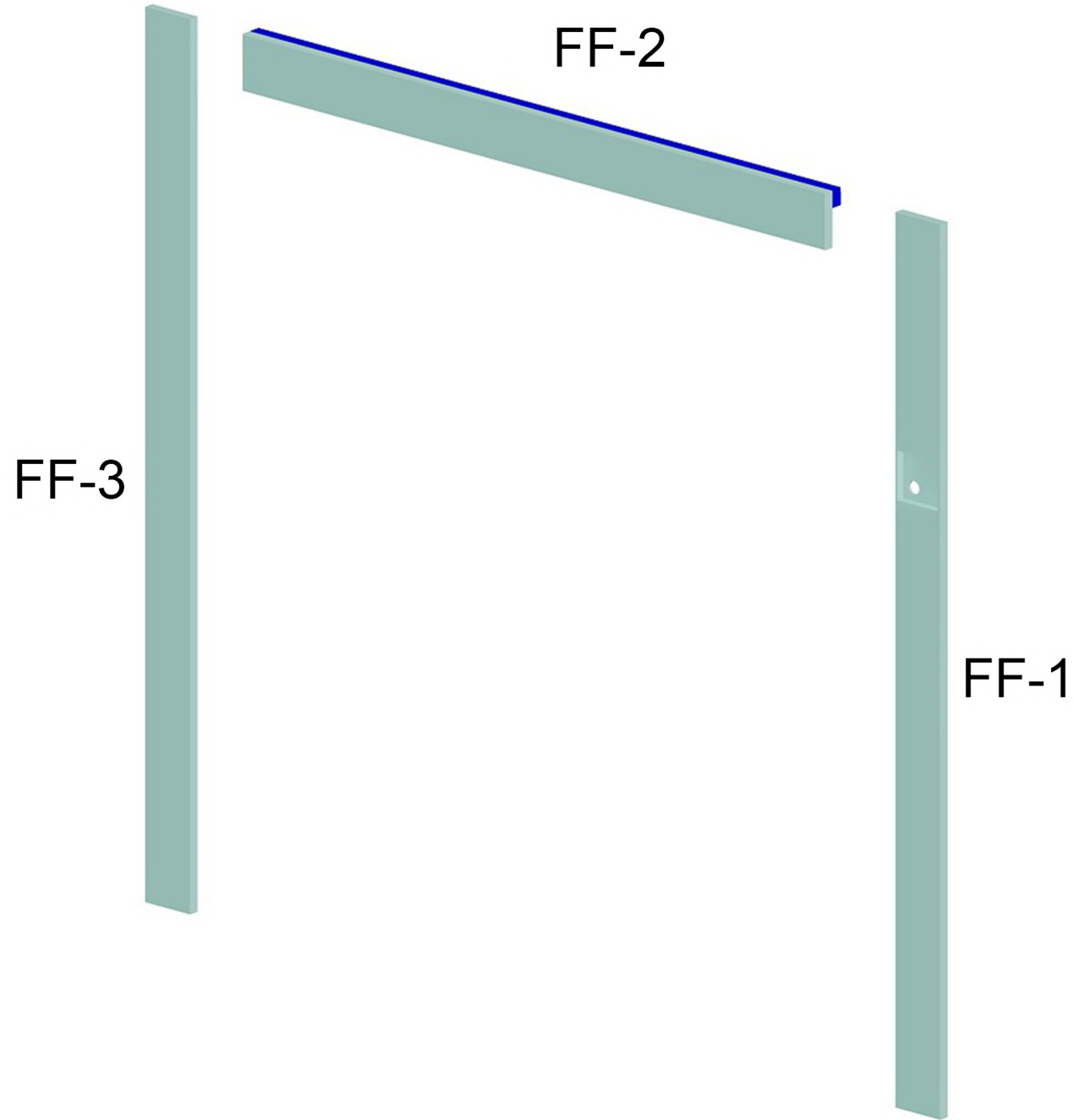

# 28. Fixing front frame

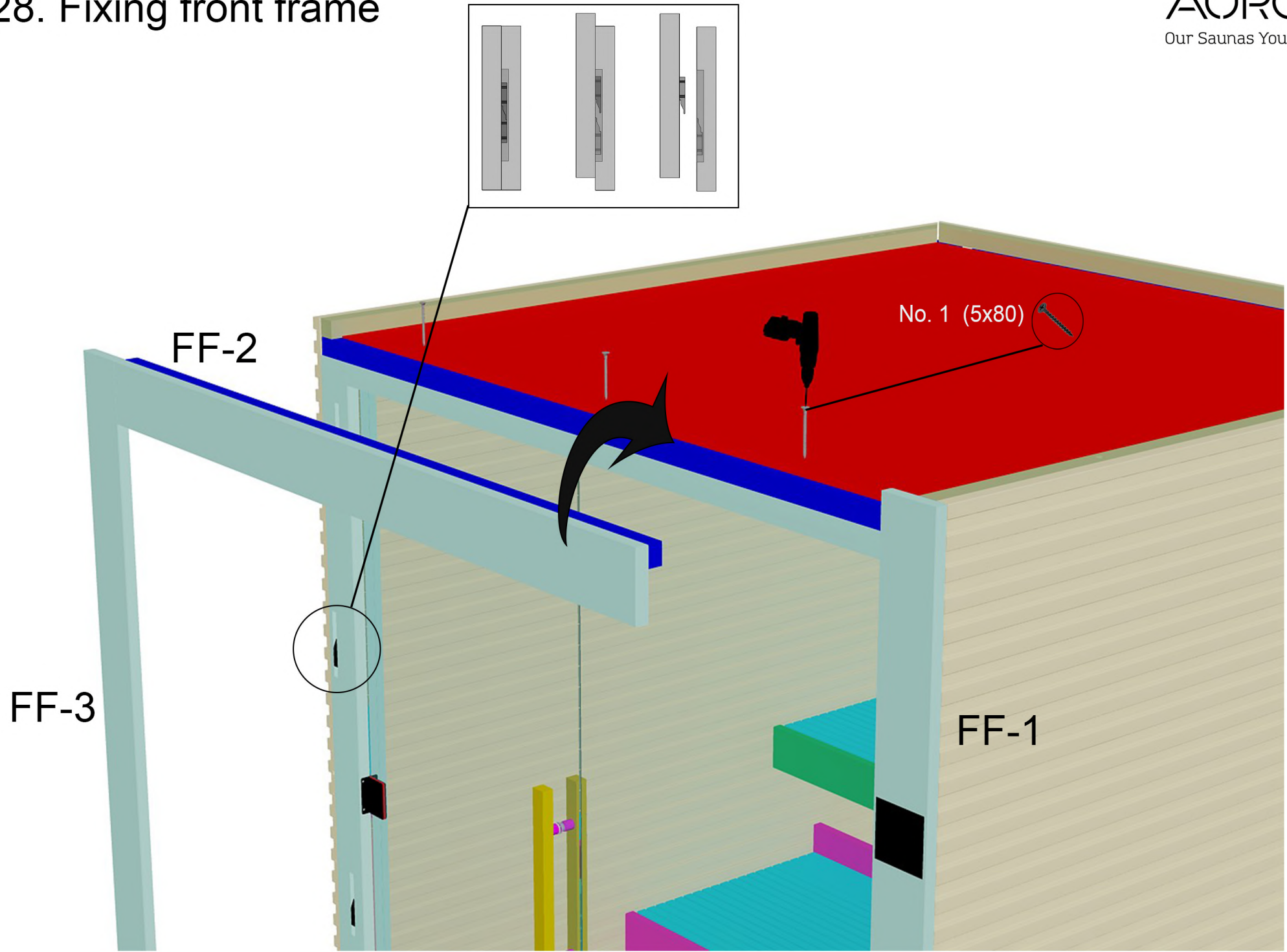

# 29. Wiring on ceiling

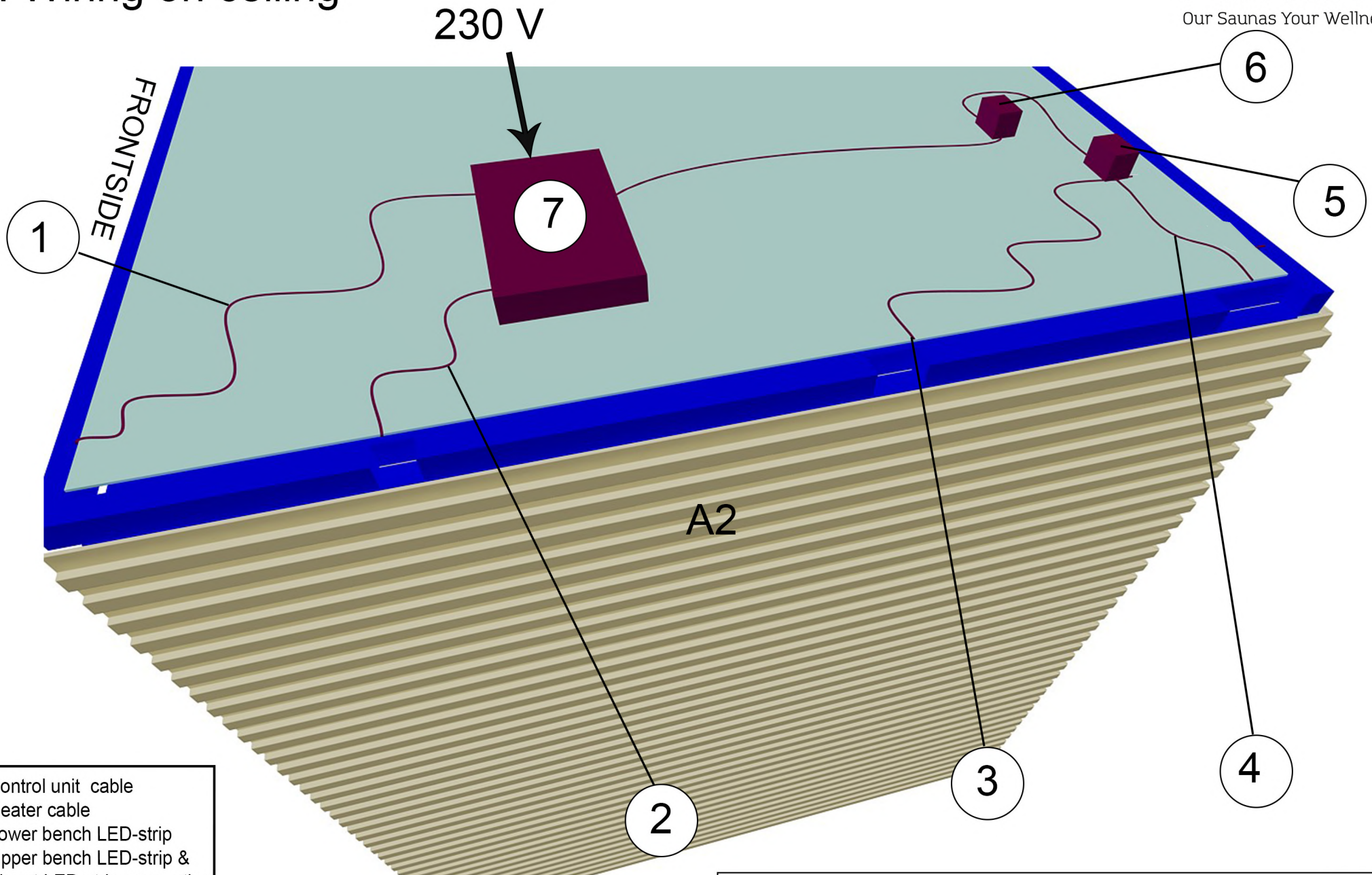

- 1. Control unit cable
- 2. Heater cable
- 3. Lower bench LED-strip
- 4. Upper bench LED-strip & Backrest LED-strip connection
- 5. LED-strip junction boxes
- 6. Transformer
- 7. Power unit

Always use a certified electrician !